

PERI Rental Criteria

HANDSET Alpha

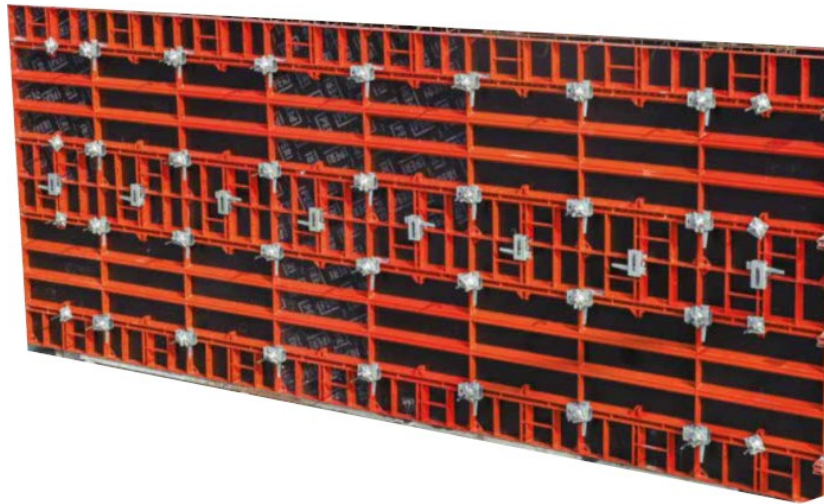

Contact

PERI GmbH
Formwork Scaffolding
Engineering
 P.O. Box 1264
 89264 Weissenhorn, Germany
 Phone +49 (0) 7309.950-0
 Fax +49 (0) 7309.951-0
 rental-criteria@peri.de

Content	Page	Changes made	Date Initial	Page
Panel	2	New Version	09/2020 fw	
Internal Corner	6	Image changed	01/2023 fw	4
External Corner	9	Bolts Nuts at external corners added	01/2023 fw	10
Alignment clamp	11	Wedge Clip separated	01/2023 fw	12
Wedge Clip	12	Frame Holder HSA added	01/2023 fw	19
Compensation Clamp	13	Article list added Alpha column articles added	05/2023 fw	3
Walers	15			
Scaffold Bracket	17			
Guardrail Post	18			

PERI Rental Criteria

HANDSET Alpha



Panel	No.	Name	Article number
-------	-----	------	----------------

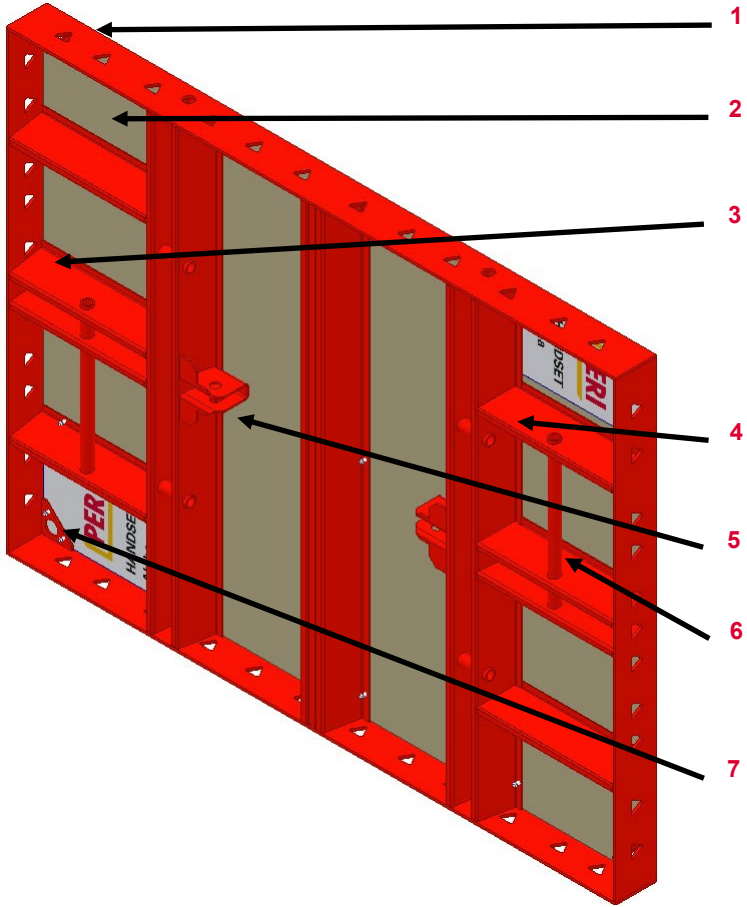











1	Frame
2	Plywood 12 mm
3	Anchor Strut
4	Panel Strut
5	Braace Connector
6	Handle
7	Plywood Support

PERI Rental Criteria

HANDSET Alpha

















Panel	Description	Instruction	Billing	Type
	Dents in Frame			
	<ul style="list-style-type: none"> ■ If possible 			
	<ul style="list-style-type: none"> ■ Or if not possible 			
	Connection holes soiled with concrete			

PERI Rental Criteria

HANDSET Alpha



Panel	Description	Instruction	Billing	Type
 <p>Samsung Quad Camera Shot with my Galaxy A31</p>	<p>Strut bent</p> <ul style="list-style-type: none"> ■ If possible ■ Or if not possible 	<ul style="list-style-type: none">   	<ul style="list-style-type: none">   	<ul style="list-style-type: none">  
	<p>Brace Connector bent</p> <ul style="list-style-type: none"> ■ If possible ■ Or if not possible 	<ul style="list-style-type: none">   	<ul style="list-style-type: none">   	<ul style="list-style-type: none">  

PERI Rental Criteria

HANDSET Alpha



Panel	Description	Instruction	Billing	Type
-------	-------------	-------------	---------	------



Handle bent

- If possible
- Or if not possible
- Or weld seam cracked



Element bent

- ≤ 8 mm
- Or > 8 mm



PERI Rental Criteria

HANDSET Alpha



Internal Corner	No.	Name	Article number
-----------------	-----	------	----------------

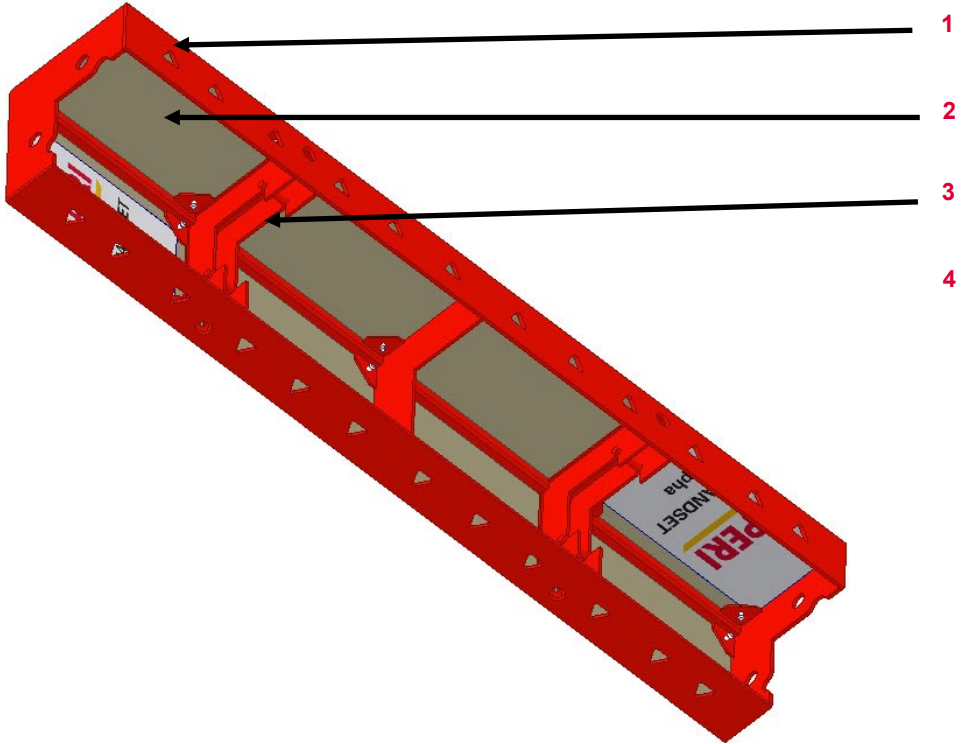











1	Frame
2	Birch Plywood
3	Strut

Valid for	Article Number
Internal Corner HSA 300	135840
Internal Corner HSA 150	135830
Internal Corner HSA 120	135835

PERI Rental Criteria

HANDSET Alpha



Internal Corner	Description	Instruction	Billing	Type
	Dents in Frame			
	<ul style="list-style-type: none"> <li data-bbox="846 518 1294 614">■ If possible 			
	<ul style="list-style-type: none"> <li data-bbox="846 678 1294 917">■ Or if not possible 			
	Connection holes soiled with concrete			

PERI Rental Criteria

HANDSET Alpha



Internal Corner	Description	Instruction	Billing	Type
-----------------	-------------	-------------	---------	------

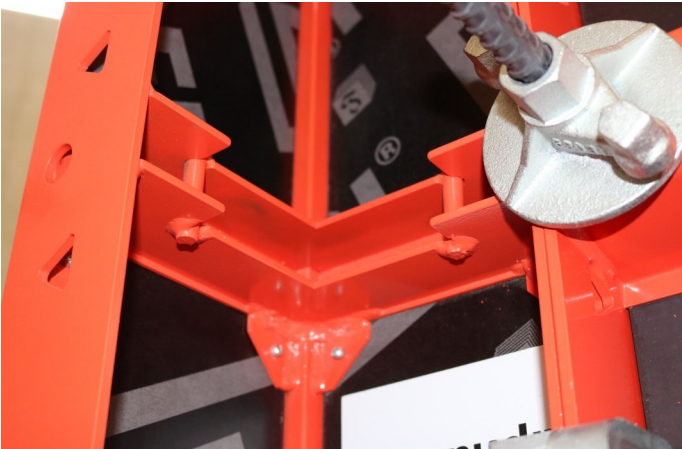

Strut bent

- If possible
- Or if not possible

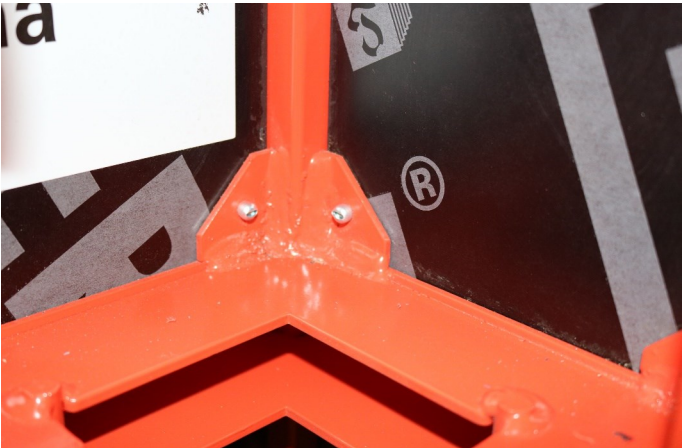

Plywood support bent

- If possible
- Or if not possible



PERI Rental Criteria

HANDSET Alpha



External Corner (135620 135623 138789 138784 138777)	Description	Instruction	Billing	Type
--	-------------	-------------	---------	------



Bent

- If possible
- Or if not possible



088244



Connection Holes soiled

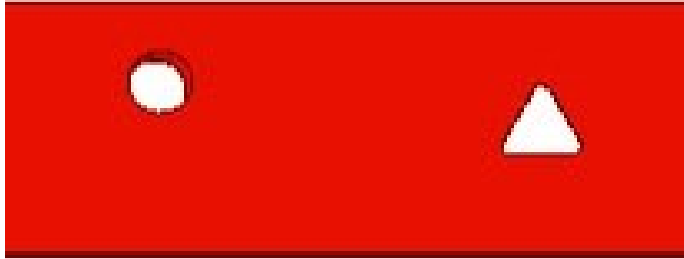

PERI Rental Criteria

HANDSET Alpha



External Corner (135620 135623)	Description	Instruction	Billing	Type
-----------------------------------	-------------	-------------	---------	------

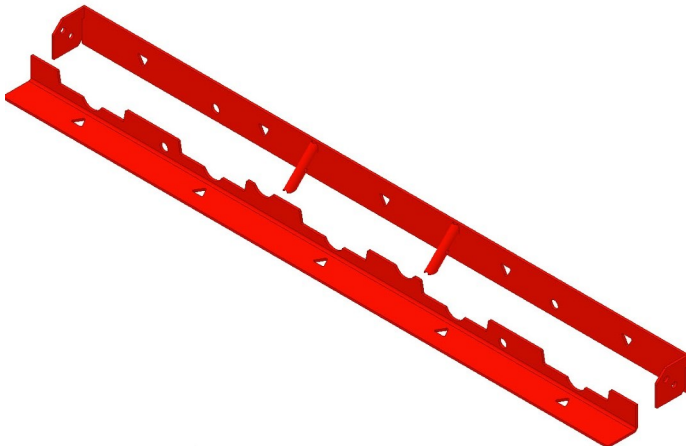

Seperated

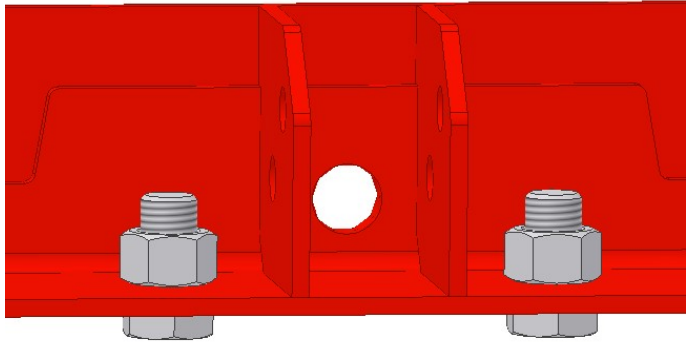

Bolts | Nuts missing







710231 (Bolt)
710229 (Nut)

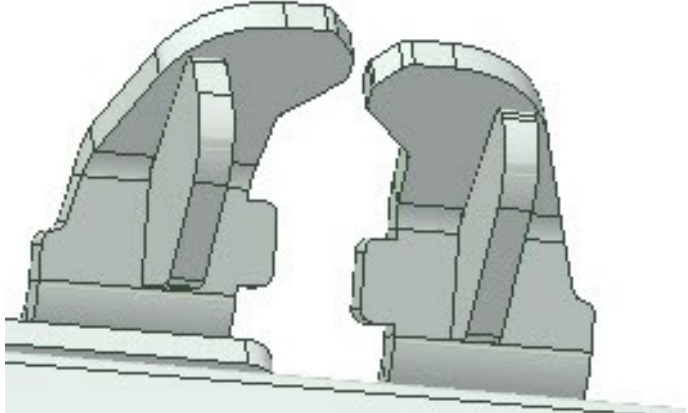
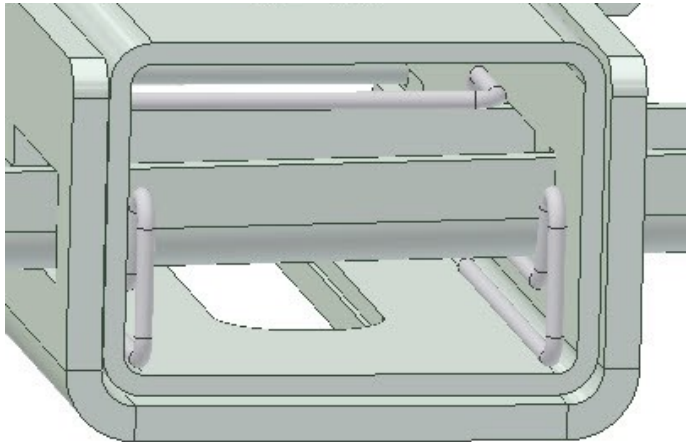

PERI Rental Criteria

HANDSET Alpha



Alignment Clamp HSA (135745)	Description	Instruction	Billing	Type
	Claws bent			
	<ul style="list-style-type: none"> <li data-bbox="846 571 1294 619">■ If possible <li data-bbox="846 715 1294 746">■ Or if not possible 	<div style="display: flex; flex-direction: column; align-items: center;"> <div data-bbox="1294 555 1375 619" style="margin-bottom: 10px;"></div> <div data-bbox="1294 689 1375 753" style="margin-bottom: 10px;"></div> </div>	<div style="display: flex; flex-direction: column; align-items: center;"> <div data-bbox="1805 555 1877 619" style="margin-bottom: 10px;"></div> <div data-bbox="1805 689 1877 753" style="margin-bottom: 10px;"></div> </div>	<div style="display: flex; flex-direction: column; align-items: center;"> <div data-bbox="2078 555 2163 619" style="margin-bottom: 10px;"></div> <div data-bbox="2078 689 2163 753" style="margin-bottom: 10px;"></div> </div>
	Spring missing	<div style="display: flex; align-items: center;">  135731 (Spring) </div>	<div style="display: flex; align-items: center;">  089409 </div>	

PERI Rental Criteria

HANDSET Alpha



Wedge Clip HSA (135818)	Description	Instruction	Billing	Type
-------------------------	-------------	-------------	---------	------



Bent

- If possible
- Or if not possible



088244



Parts separated



PERI Rental Criteria

HANDSET Alpha



Compensation Clamp HSA (135763)	Description	Instruction	Billing	Type
---------------------------------	-------------	-------------	---------	------

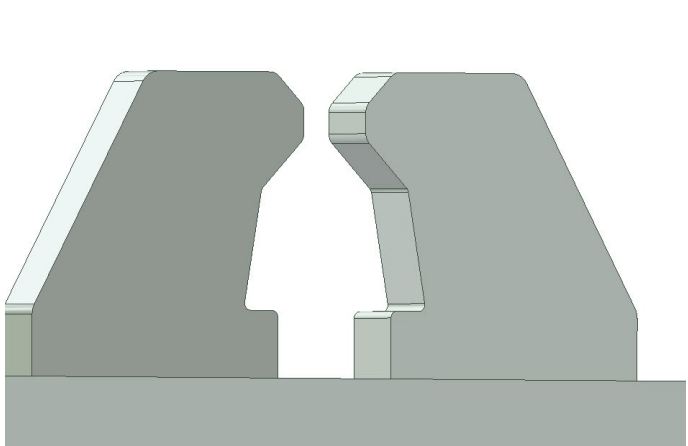

Claws bent

- If possible
- Or if not possible



088244

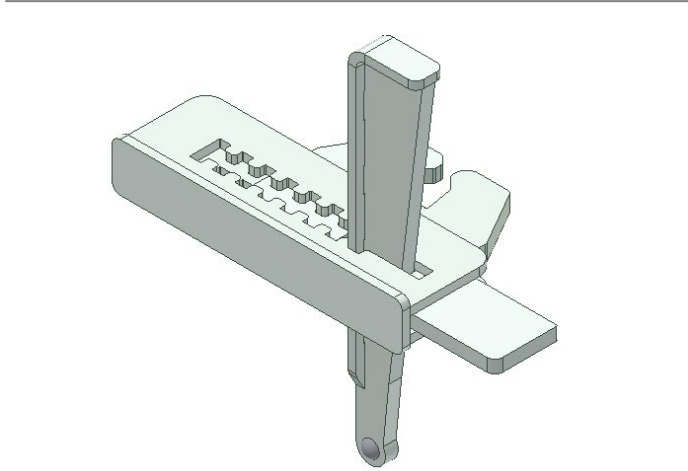

Wedge missing



135749 (Wedge)
107521 (Rivet)



089410



PERI Rental Criteria

HANDSET Alpha



HSA Compensation Waler 95 (135643)	Description	Instruction	Billing	Type
------------------------------------	-------------	-------------	---------	------

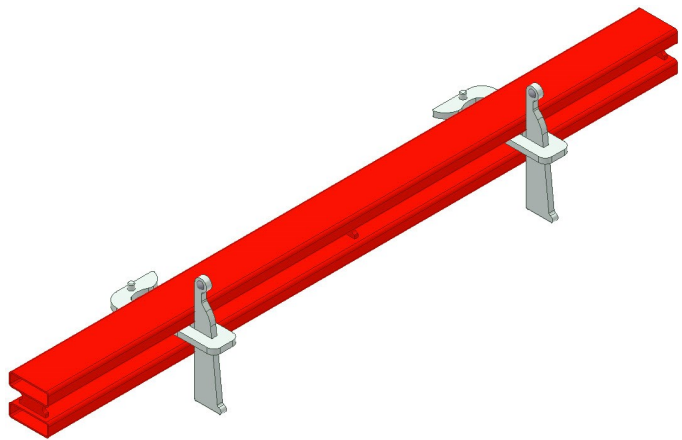

Bent

- If possible
- Or if not possible



088244

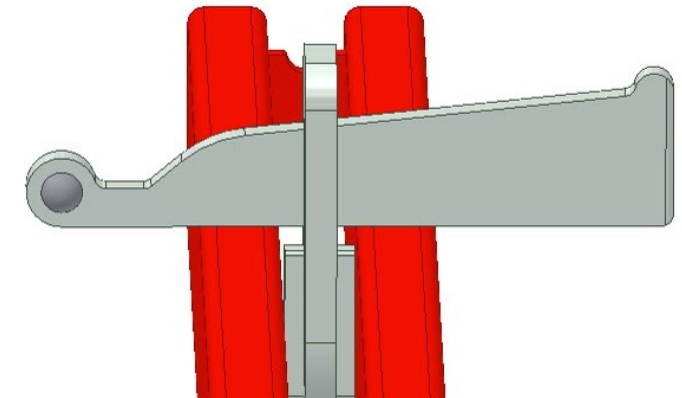

Wedge missing



135638 (Wedge)
107521 (Rivet)



PERI Rental Criteria

HANDSET Alpha

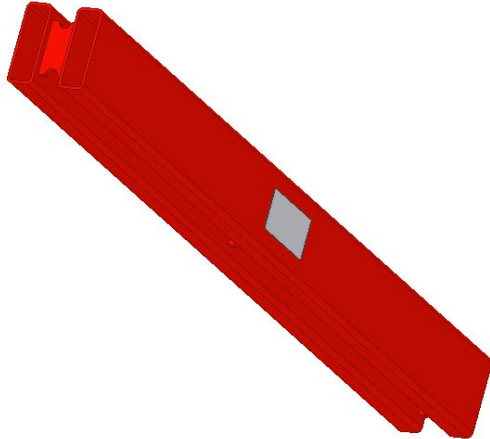
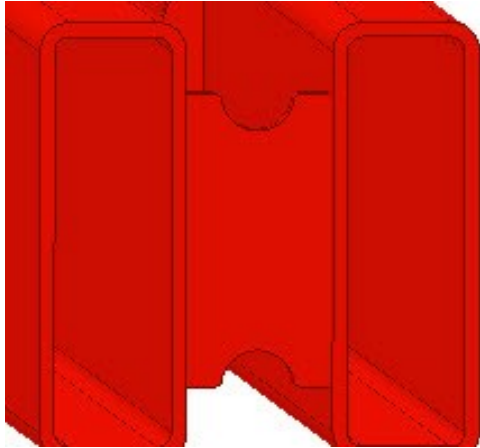

HSA Stopend Waler (135635 135631)	Description	Instruction	Billing	Type
	Dents in tube			
	■ ≤ 3 mm	✓		
	■ Or > 3 mm and bending possible		088244	
	■ Or if bending not possible			
	Spacer missing			

PERI Rental Criteria

HANDSET Alpha



Filler Support (135813 135806 135810)	Description	Instruction	Billing	Type
--	-------------	-------------	---------	------











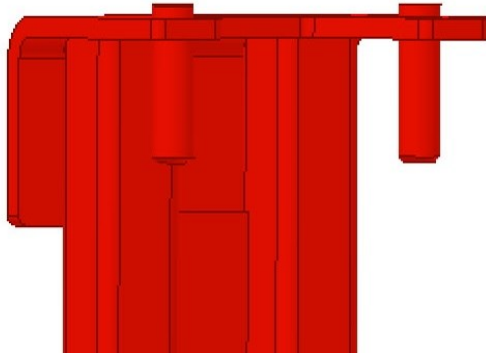







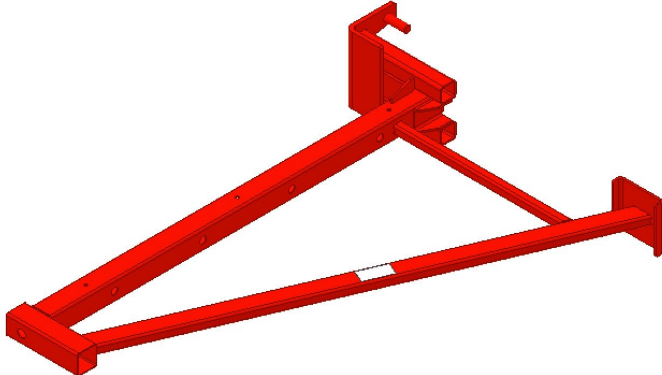

	<p>Connection holes soiled</p>			
--	---------------------------------------	--	--	--

	<p>Plates bent</p> <ul style="list-style-type: none"> ■ If possible ■ Or if not possible 		088244	

PERI Rental Criteria

HANDSET Alpha



Scaffold Bracket HSA (135907 138802)	Description	Instruction	Billing	Type
	<p>Hooks bent</p>			
	<ul style="list-style-type: none"> ■ If possible 		 088244	
	<ul style="list-style-type: none"> ■ Or if not possible 			
<ul style="list-style-type: none"> ■ Or cracks in material 				
	<p>Dents in tube</p>			
	<ul style="list-style-type: none"> ■ ≤ 3 mm 			
	<ul style="list-style-type: none"> ■ Or > 3 mm and bending possible 		 088244	
<ul style="list-style-type: none"> ■ Or > 3 mm and bending not possible 				

PERI Rental Criteria

HANDSET Alpha



Guardrail Post HSGP - 2 (116292)	Description	Instruction	Billing	Type
	<p>Slider deformed missing</p>	<p> 115673 (Slider)</p>	<p> 088227</p>	
	<p>Wedge broken</p>	<p></p>	<p> 088227</p>	
	<p>Bent</p> <p>■ > 5 mm</p>	<p></p>	<p></p>	

PERI Rental Criteria

HANDSET Alpha



Frame Holder HSA (138326 138804)	Description	Instruction	Billing	Type
------------------------------------	-------------	-------------	---------	------

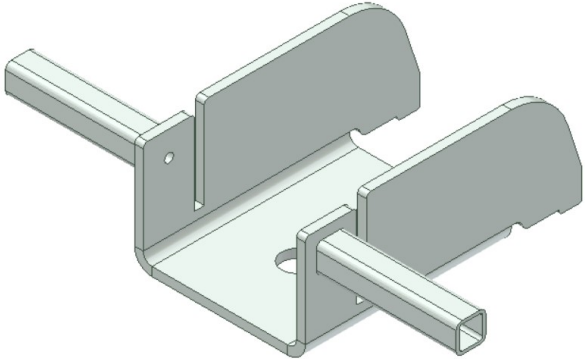

Bent

















- If possible
- Or if not possible



PERI Rental Criteria

Glossar Icons



Icon	Significance	Icon	Significance	Icon	Significance
	Not Ok– material is scrap		Billing necessary (customer)		Optical damage
	OK– material stays in rental park		No Billing necessary		Functional damage
	Scrap material– it's not permitted to hand out the material because of safety aspects		Shorten material		Functional damage— it's not permitted to hand out the material
	Repair according to instruction		Mark material		Static damage— it's not permitted to hand out the material
	Fix material cold—Afterwards check weld seams and bordering components		Replace damaged material		
	Repair after local economic efficiency calculation		Replace missing material		
	Clean material				