

# PERI Rental Criteria

## Cantilevered Parapet Bracket

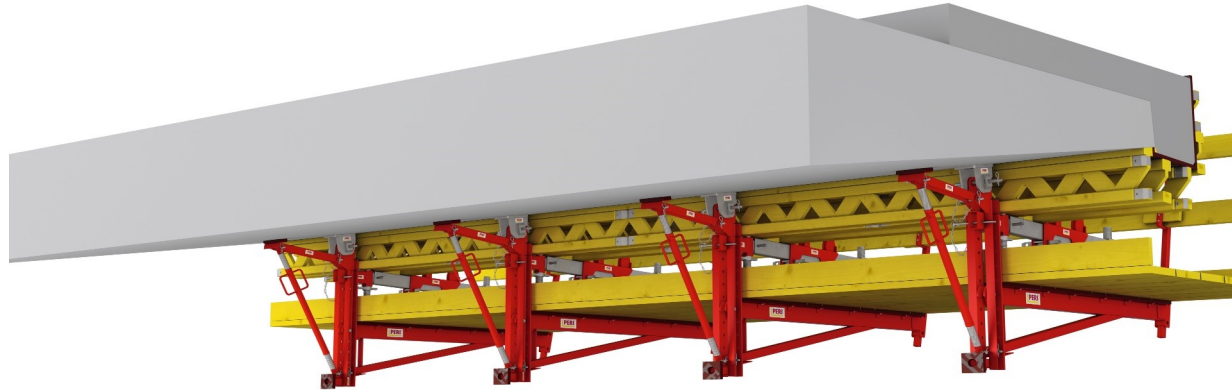

### Contact

**PERI GmbH**  
**Formwork Scaffolding**  
**Engineering**  
 P.O. Box 1264  
 89264 Weissenhorn, Germany  
 Phone +49 (0) 7309.950-0  
 Fax +49 (0) 7309.951-0  
 rental-criteria@peri.de

Content	Page	Changes made	Date   Initial	Page
Bracket Post	2	New Version	05/19   fw	
Platform Cantilever Beam	4	Articles 134161 and 134169 added	08/19   fw	2; 17
Formwork Support	7			
Bracket Cantilever	10			
Formwork Fixing VGK- 2	13			
Formwork Post	15			
Suspension Head	18			
Brace Connector	19			
Glossary	20			

# PERI Rental Criteria

## Cantilevered Parapet Bracket



Bracket Post VGK	No.	Name	Article number
------------------	-----	------	----------------

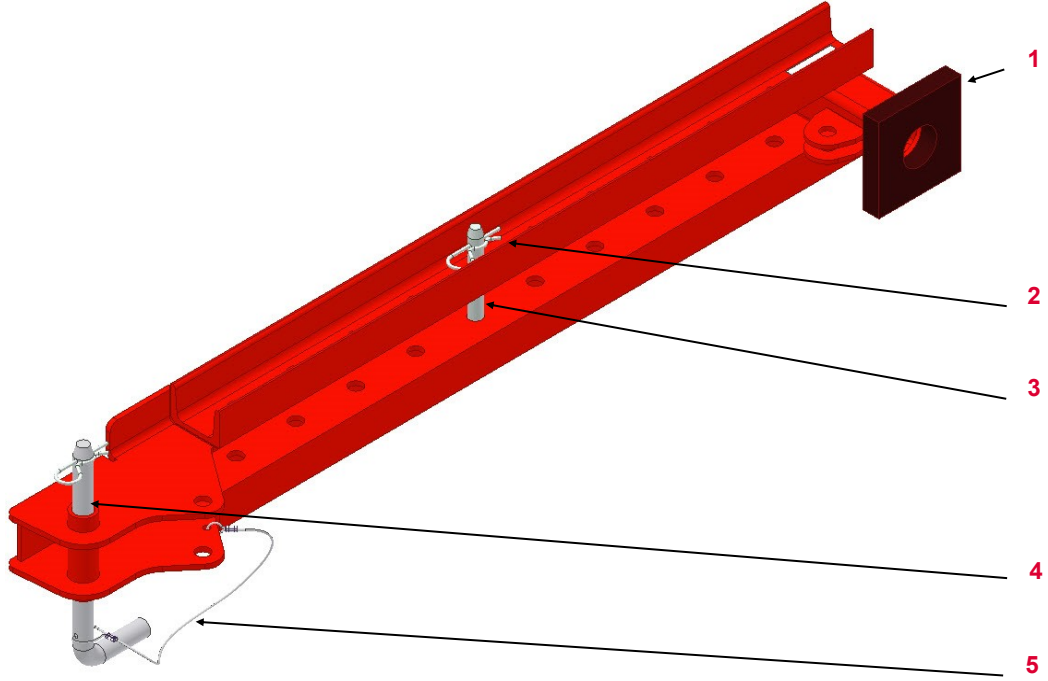











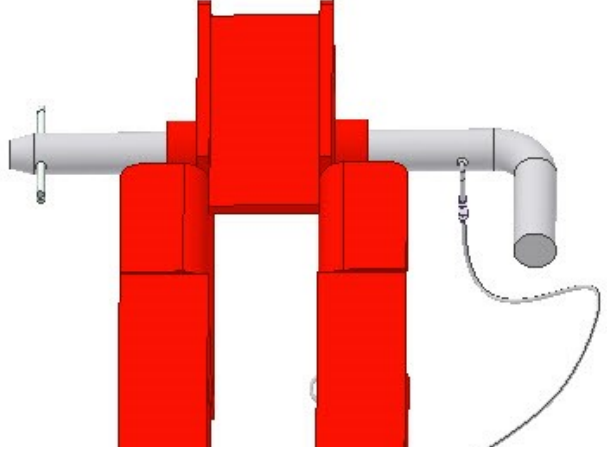

1	Support FinPly	124396
2	Cotter Pin	018060
3	Pin D=16x90	118463
4	Pin 20x260	113012
5	Stranded Rope	127303

Valid for	
Bracket Post VGK 70	134161
Bracket Post VGK 110	124404
Bracket Post VGK 139	124427

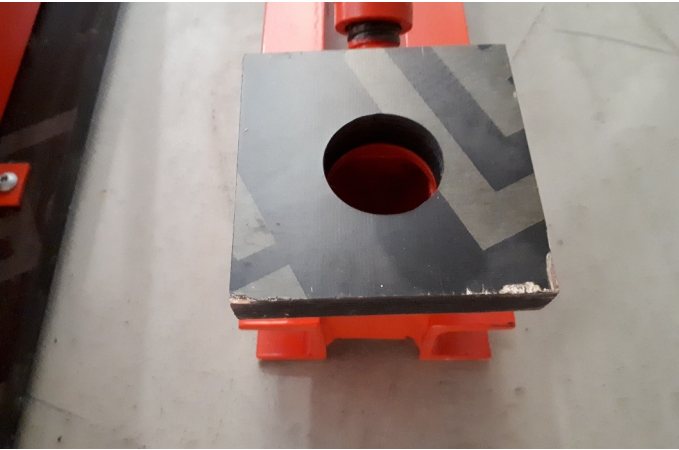
# PERI Rental Criteria

## Cantilevered Parapet Bracket



Bracket Post VGK	Description	Instruction	Billing	Type
	<p><b>Pin   Cotter Pin   Robe</b></p> <ul style="list-style-type: none"> <li>■ Missing</li> <li>■ Or damaged due to force</li> </ul>	<ul style="list-style-type: none"> <li></li> <li></li> </ul>	<ul style="list-style-type: none"> <li></li> <li></li> </ul>	<ul style="list-style-type: none"> <li></li> <li></li> </ul>
	<p><b>Support FinPly</b></p> <ul style="list-style-type: none"> <li>■ Worn</li> <li>■ Or missing</li> </ul>	<ul style="list-style-type: none"> <li></li> <li></li> </ul>	<ul style="list-style-type: none"> <li></li> <li></li> </ul>	<ul style="list-style-type: none"> <li></li> <li></li> </ul>

# PERI Rental Criteria

## Cantilevered Parapet Bracket



### Platform Cantilever Beam VGK 170 (124447)

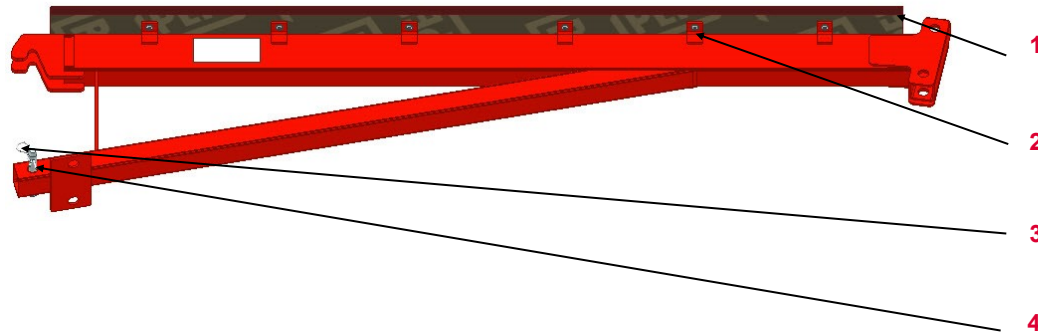

No.	Name	Article number
1	Nail Board	124428
2	Spax 8x20	024550
3	Cotter Pin	018060
4	Pin 16x90	118463

# PERI Rental Criteria

## Cantilevered Parapet Bracket



Platform Cantilever Beam VGK 170	Description	Instruction	Billing	Type
----------------------------------	-------------	-------------	---------	------

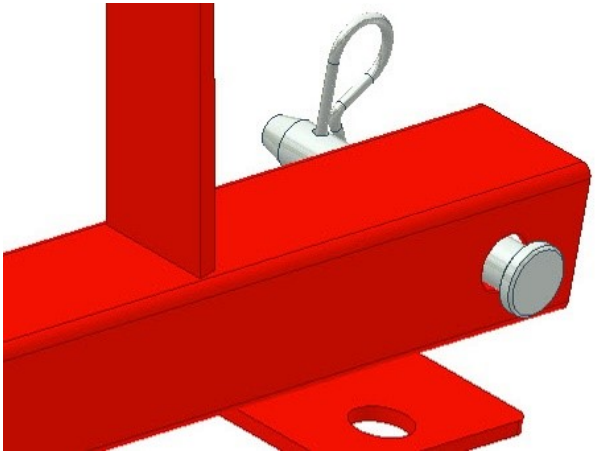

Pin | Cotter Pin missing









Nail Board Worn

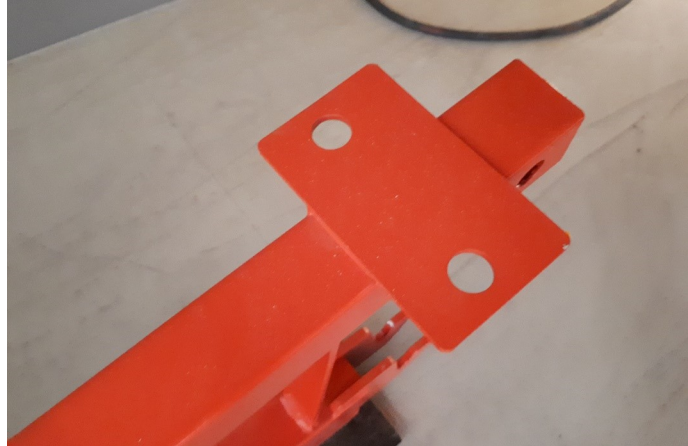

# PERI Rental Criteria

## Cantilevered Parapet Bracket



Platform Cantilever Beam VGK 170	Description	Instruction	Billing	Type
	<p><b>Plates bent</b></p> <ul style="list-style-type: none"> <li>■ If possible</li> <li>■ Or if not possible</li> </ul>	<ul style="list-style-type: none"> <li></li> <li></li> </ul>	<ul style="list-style-type: none"> <li></li> <li></li> </ul>	<ul style="list-style-type: none"> <li></li> <li></li> </ul>

# PERI Rental Criteria

## Cantilevered Parapet Bracket



Formwork Support VGK (124438)	No.	Name	Article number
-------------------------------	-----	------	----------------

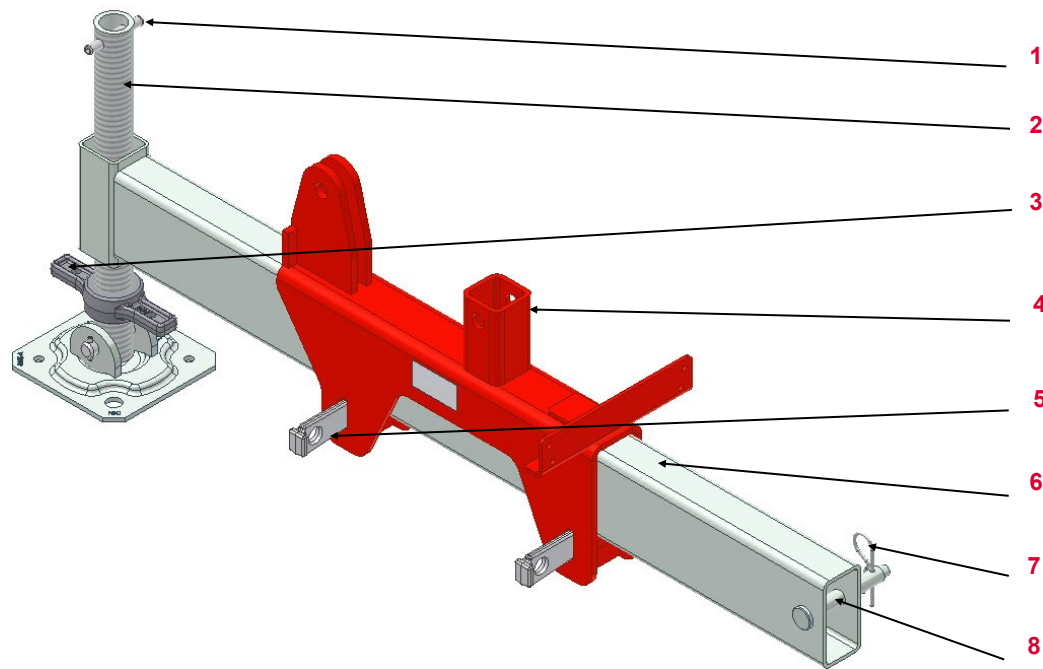

1	Sleeve	105365
2	Articulated Base Spindle	124419
3	Wing Nut	710071
4	Guide Carriage	124434
5	Wedge	024250
6	Formwork Guide	124435
7	Cotter Pin	018060
8	Pin 16x90	118463

# PERI Rental Criteria

## Cantilevered Parapet Bracket



Formwork Support VGK	Description	Instruction	Billing	Type
----------------------	-------------	-------------	---------	------

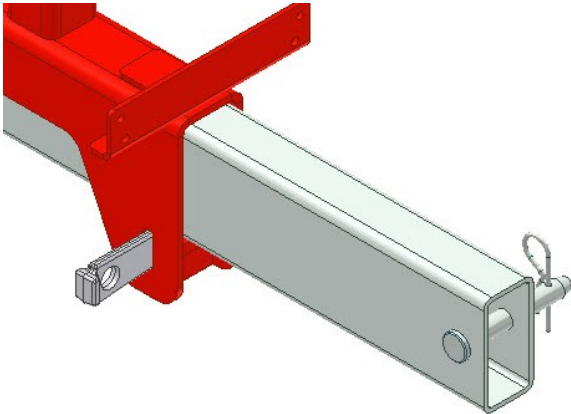

Bolt | Pin | Cotter Pin missing

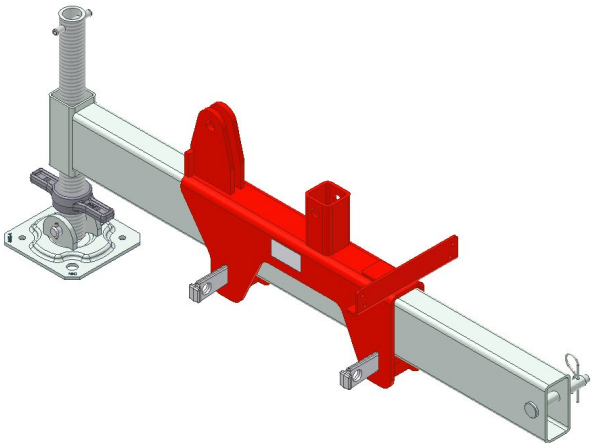

Parts bent

■ If possible













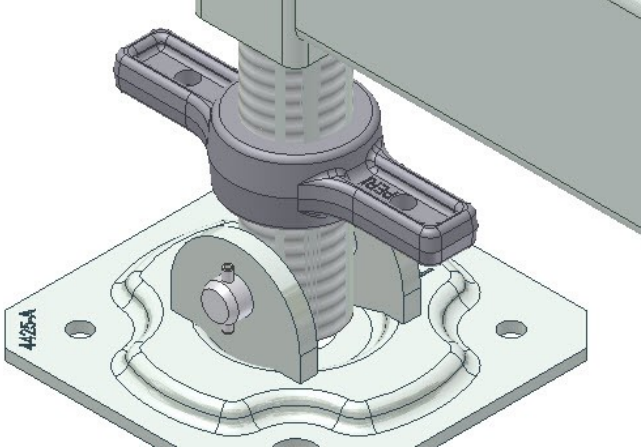

■ Or if not possible

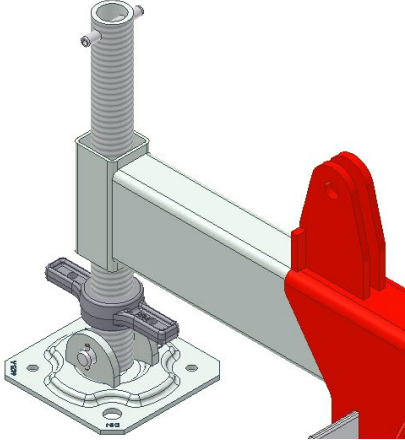

# PERI Rental Criteria

## Cantilevered Parapet Bracket



Formwork Support VGK	Description	Instruction	Billing	Type
	<p><b>Wng Nut</b></p> <ul style="list-style-type: none"> <li>■ Missing</li> </ul>			
	<ul style="list-style-type: none"> <li>■ Or damaged due to force</li> </ul>			
	<p><b>Function of spindle not given</b></p> <ul style="list-style-type: none"> <li>■ Due to weariness</li> </ul>			
	<ul style="list-style-type: none"> <li>■ Or damaged due to force</li> </ul>			

# PERI Rental Criteria

## Cantilevered Parapet Bracket



### Bracket Cantilever VGK 50 (124455)

No.	Name	Article number
-----	------	----------------

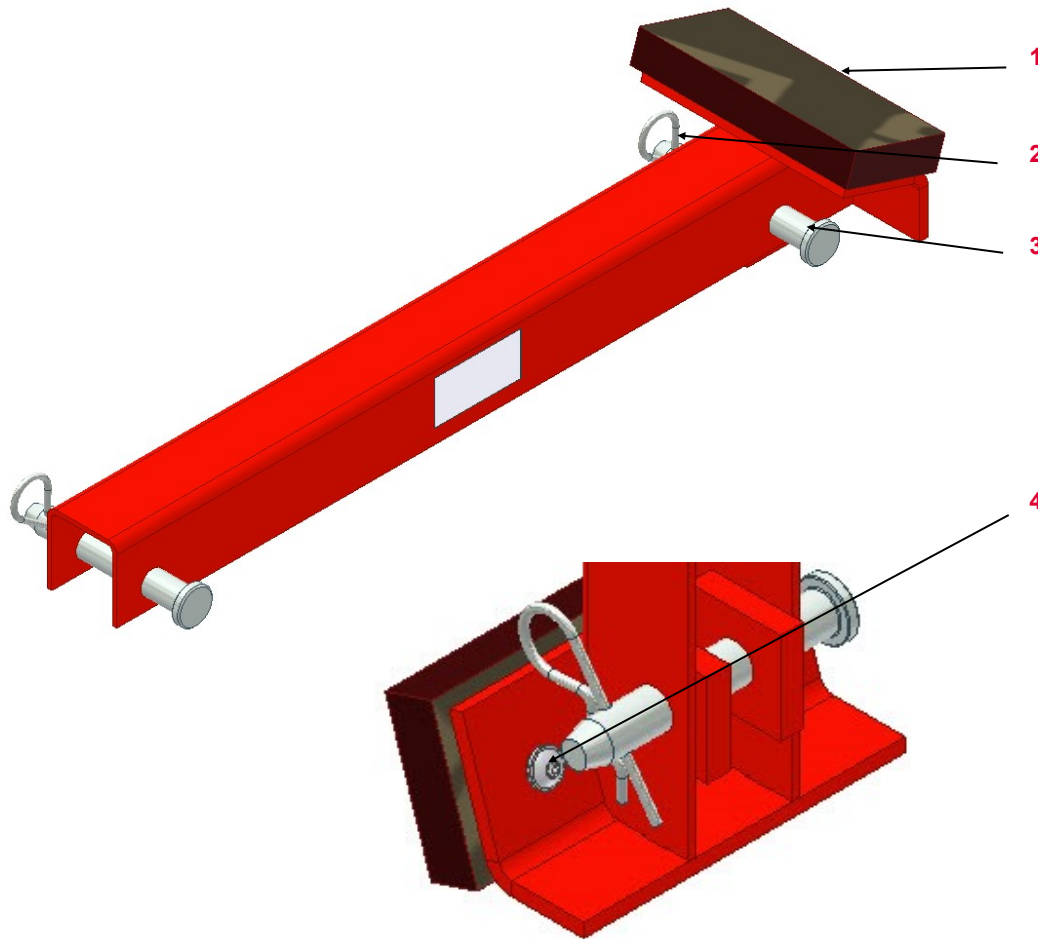









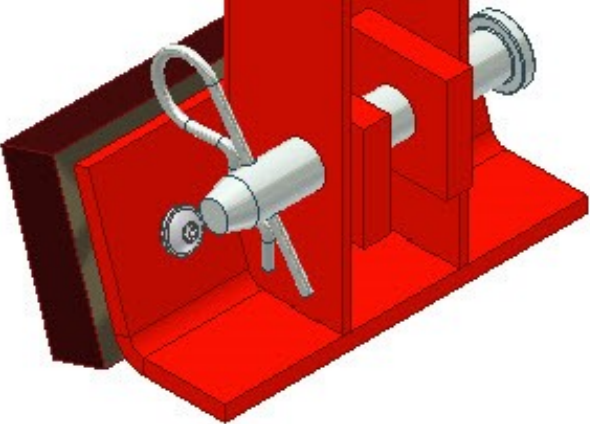

1	Formlining	124449
2	Cotter Pin	018060
3	Pin 16x90	118463
4	Spax 8x20	024550

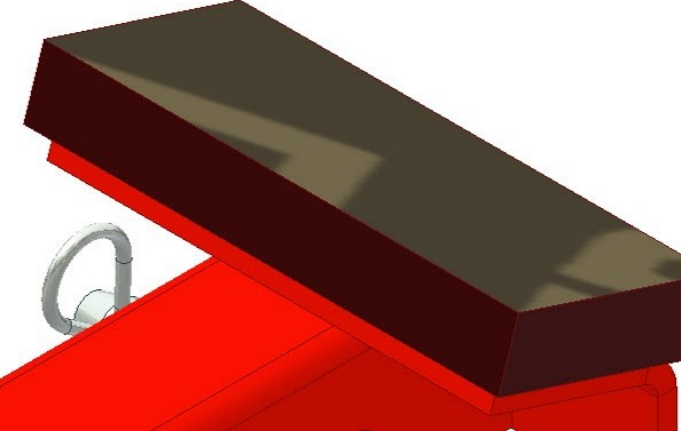
# PERI Rental Criteria

## Cantilevered Parapet Bracket



Bracket Cantilever VGK (124455)	Description	Instruction	Billing	Type
	<p>Bolt   Cotter Pin missing</p>			
	<p><b>Formlining</b></p> <ul style="list-style-type: none"> <li>■ Missing</li> <li>■ Or worn</li> </ul>	  	  	  

# PERI Rental Criteria

## Cantilevered Parapet Bracket

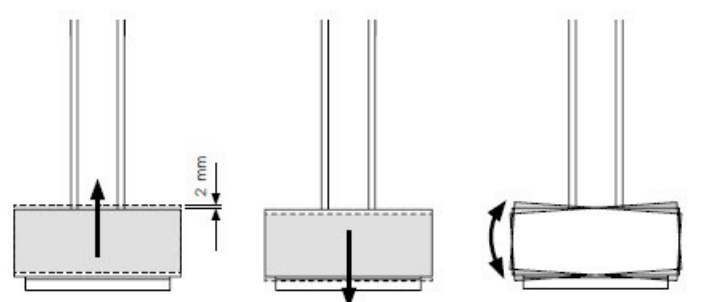

Bracket Cantilever VGK (124455)	Description	Instruction	Billing	Type
	<p><b>Function of Formlining</b></p> <ul style="list-style-type: none"> <li>■ Formlining moveable—approx. 2 mm forwards, back and twistable</li> <li>■ Or if not moveable</li> <li>■ Or sealing damaged</li> </ul>	<ul style="list-style-type: none"> <li>✓</li> <li>⚙</li> <li>⚙</li> </ul>	<ul style="list-style-type: none"> <li>🚫</li> <li>🔧</li> <li>🔧</li> </ul>	<ul style="list-style-type: none"> <li>⚙</li> <li>⚙</li> <li>⚙</li> </ul>

# PERI Rental Criteria

## Cantilevered Parapet Bracket



Formwork Fixing VGK 2 (124394)	No.	Name	Article number
--------------------------------	-----	------	----------------

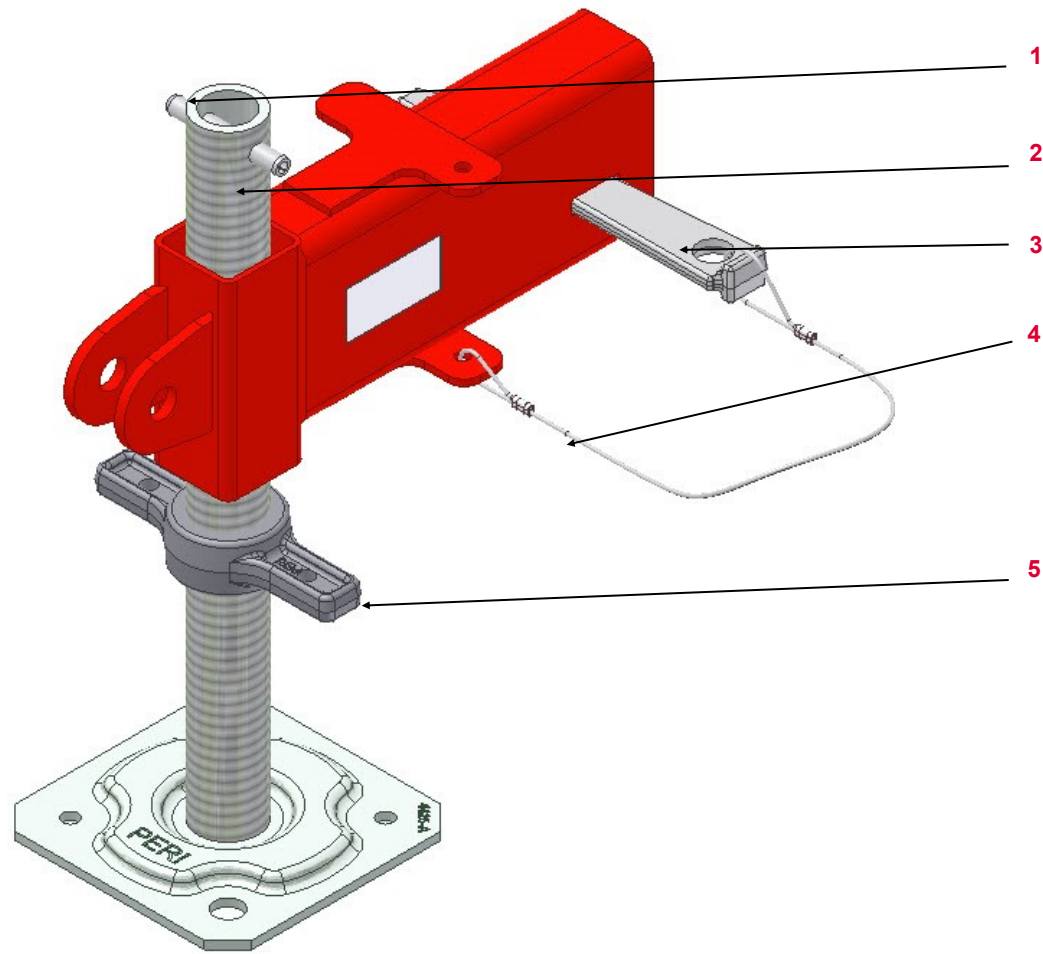









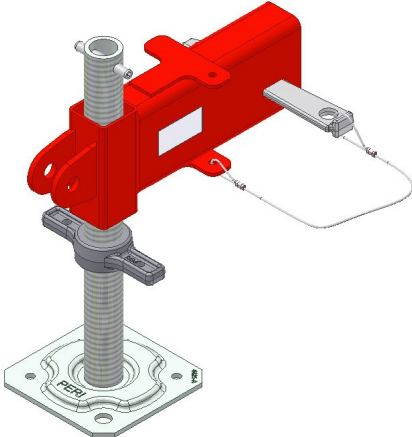

1	Sleeve	722457
2	Base Spindle	124380
3	Wedge	024250
4	Robe	127303
5	Wing Nut	710071

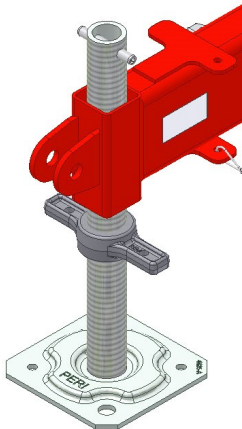
# PERI Rental Criteria

## Cantilevered Parapet Bracket



Formwork Fixing VGK 2	Description	Instruction	Billing	Type
	<p><b>Parts</b></p>			
	<ul style="list-style-type: none"> <li>■ Missing</li> </ul>			
	<p><b>Function of Base Spindle not given</b></p>			
	<ul style="list-style-type: none"> <li>■ Damaged due to force</li> </ul>			
<ul style="list-style-type: none"> <li>■ Or due to weariness</li> </ul>				

# PERI Rental Criteria

## Cantilevered Parapet Bracket



Formwork Post (124371)   Formwork Post Extension (124360)	No.	Name	Article number
---	-----	------	----------------

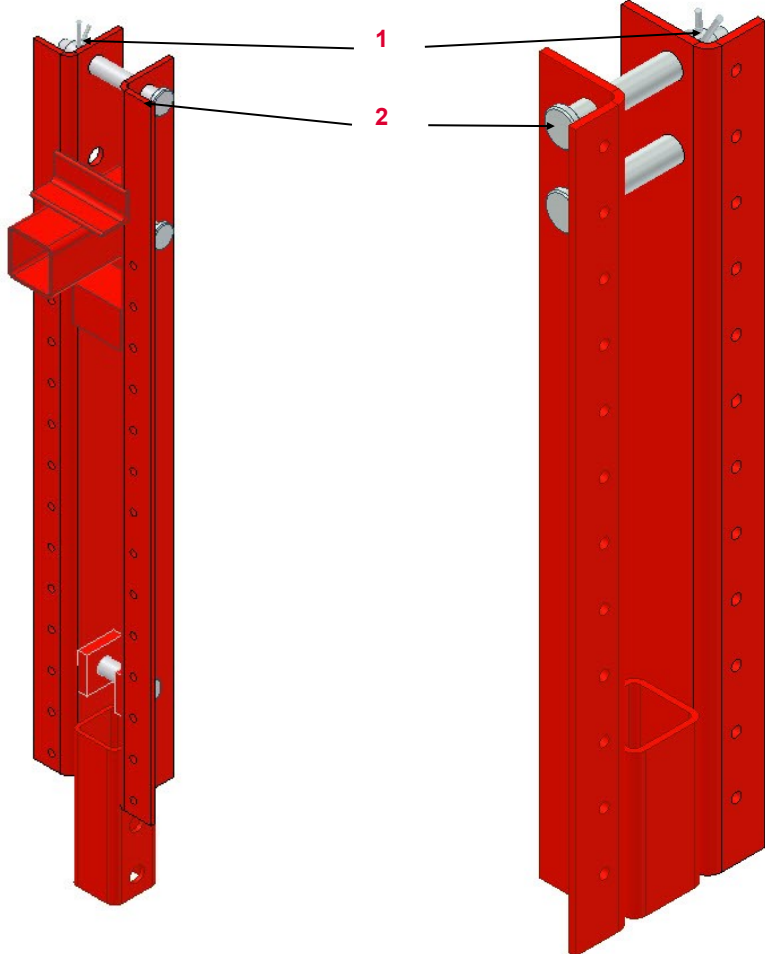









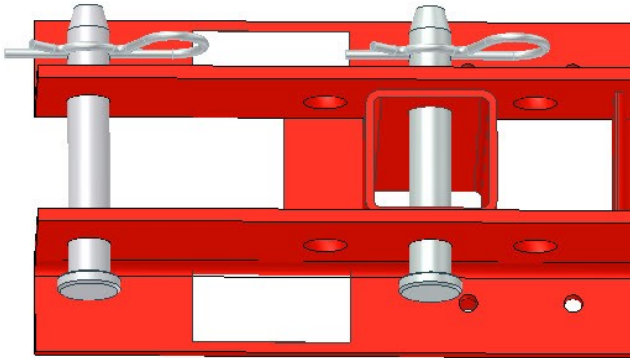

1	Cotter Pin	018060
2	Pin 16x90	118463

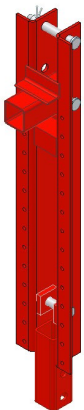
# PERI Rental Criteria

## Cantilevered Parapet Bracket



Formwork Post   Formwork Post Extension	Description	Instruction	Billing	Type
	<p><b>Pin   Cotter Pin missing</b></p>			
	<p><b>Bent</b></p> <ul style="list-style-type: none"> <li>■ If possible</li> <li>■ Or if not possible</li> </ul>	<p>■ If possible</p>  <p>■ Or if not possible</p> 	<p>■ If possible</p>  <p>■ Or if not possible</p> 	<p>■ If possible</p>  <p>■ Or if not possible</p> 

# PERI Rental Criteria

## Cantilevered Parapet Bracket



Formwork Post VGK 60 (134169)	Description	Instruction	Billing	Type
-------------------------------	-------------	-------------	---------	------

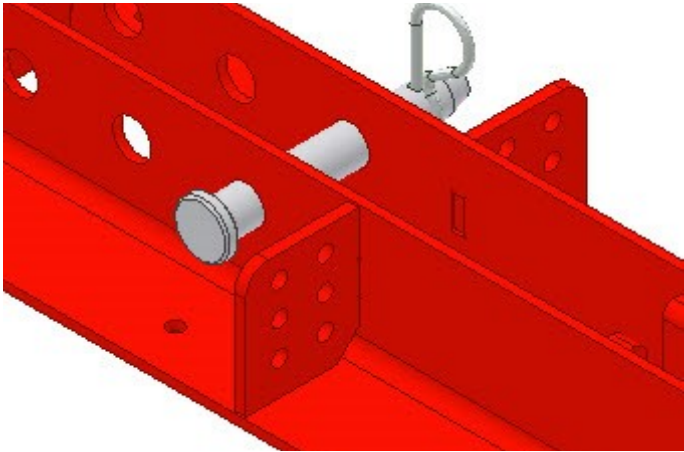

Pin | Cotter Pin missing

 118463 (Pin)  
018060 (Cotter Pin)

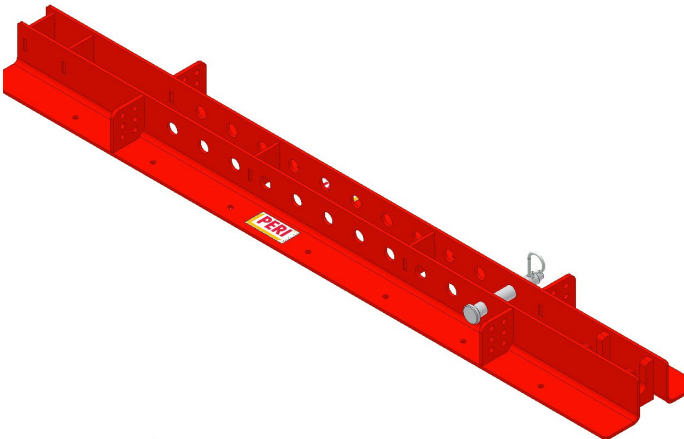

**Bent**

- If possible













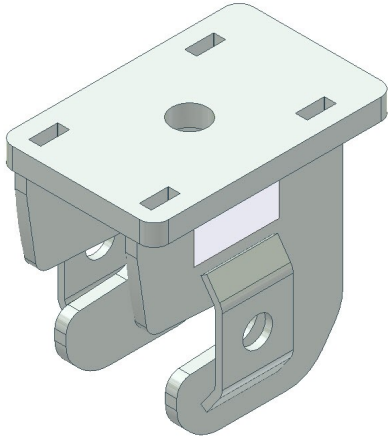





- Or if not possible

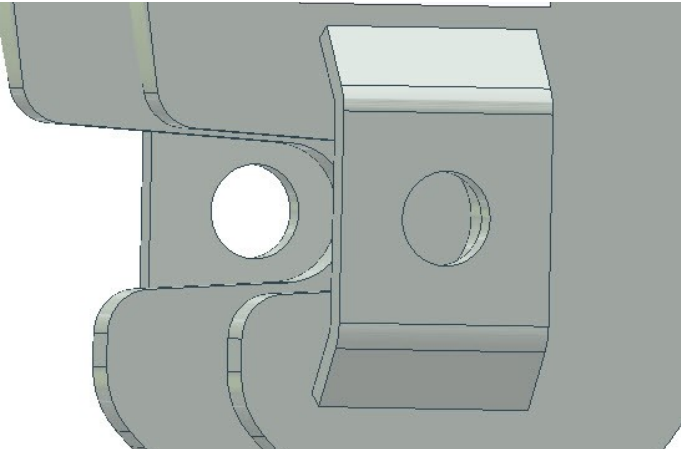

# PERI Rental Criteria

## Cantilevered Parapet Bracket









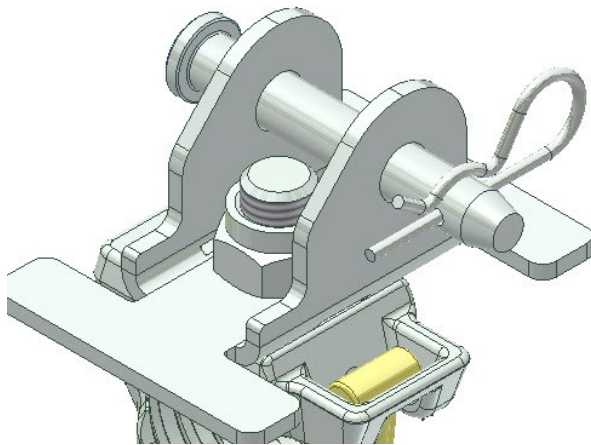

Suspension Head VGK (124413)	Description	Instruction	Billing	Type
	<b>Bent</b>			
	<ul style="list-style-type: none"> <li>■ If possible</li> </ul>			
	<ul style="list-style-type: none"> <li>■ Or if not possible</li> </ul>	 		
	<b>Geometry of drill holes</b>			
	<ul style="list-style-type: none"> <li>■ Original geometry given</li> </ul>			
	<ul style="list-style-type: none"> <li>■ Or if not given</li> </ul>	 		

# PERI Rental Criteria

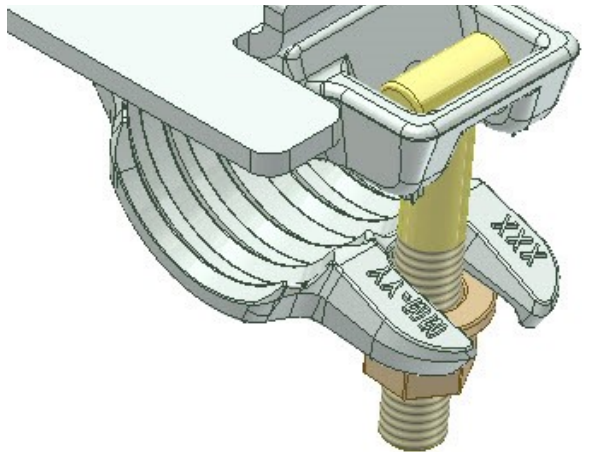
## Cantilevered Parapet Bracket



















Brace Connector VGK (124934)	Description	Instruction	Billing	Type
	<p><b>Pin   Cotter Pin missing</b></p>	 <p>710222 (Pin 16x90) 018060 (Cotter Pin)</p>		
	<p><b>Hammer Head Bolt   Nut missing</b></p>	 <p>710340 (Nut) 131316 (Hammer Head Bolt)</p>		

# PERI Rental Criteria

## Glossar Icons



Icon	Significance	Icon	Significance	Icon	Significance
	Not OK – material is scrap		Billing necessary (customer)		Optical damage
	OK—material stays in rental park		No Billing necessary		Functional damage
	Scrap material—it's not permitted to hand out the material because of safety aspects		Shorten material		Functional damage—it's not permitted to hand out the material
	Repair according to Instruction		Mark material		Static damage—it's not permitted to hand out the material
	Fix material cold– Afterwards check weld seams and bordering components		Replace damaged material		
	Repair after local economic efficiency calculation		Replace missing material		
	Clean material				