

PERI Rental Criteria | APAC
ALUMINUM Beam | AB 20C , AB 16B



AB 20C



AB 16B

Content	Page
Main Profile	2 - 3
Type of Damages	4 - 10
Legend - Icon	11

Changes Made	Date Initial	Page
	10.2019	
Alu Beam End Cap Billing Condition	5.2025	9

PERI Rental Criteria | APAC

ALUMINUM Beam | AB 20C 240



Aluminum Profile	No.	Description	Article Number
------------------	-----	-------------	----------------

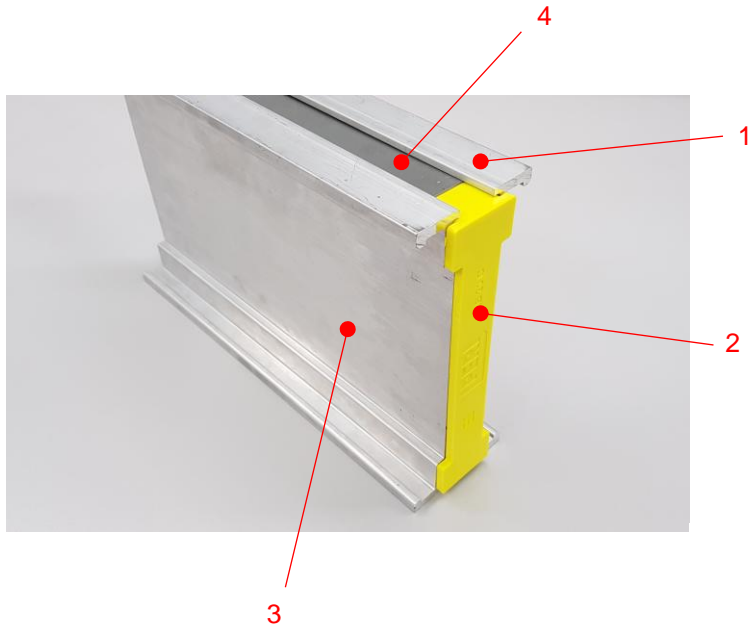

- 1 Flange
 - 2 End Cap
 - 3 Web
 - 4 Nailing Strip
- 239255

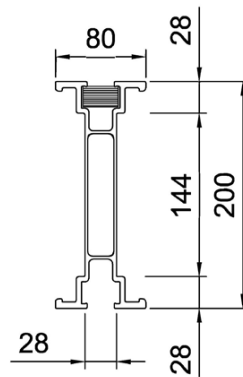

Article No.	Description	Weight (kgs)
039212	Alu Beam AB 20 C L = 0.90 m	5.72
039213	Alu Beam AB 20 C L = 1.20 m	7.62
039214	Alu Beam AB 20 C L = 1.50 m	9.53
039215	Alu Beam AB 20 C L = 1.80 m	11.43
039216	Alu Beam AB 20 C L = 2.10 m	13.34
039217	Alu Beam AB 20 C L = 2.40 m	15.24
039218	Alu Beam AB 20 C L = 2.70 m	17.15
039219	Alu Beam AB 20 C L = 3.00 m	19.05
039220	Alu Beam AB 20 C L = 3.30 m	20.96
039221	Alu Beam AB 20 C L = 3.60 m	22.86
039222	Alu Beam AB 20 C L = 3.90 m	24.77
039223	Alu Beam AB 20 C L = 4.20 m	26.67
039224	Alu Beam AB 20 C L = 4.50 m	28.58
039225	Alu Beam AB 20 C L = 4.80 m	30.48
039226	Alu Beam AB 20 C L = 5.10 m	32.39
039227	Alu Beam AB 20 C L = 5.40 m	34.29
039228	Alu Beam AB 20 C L = 5.70 m	36.20
039229	Alu Beam AB 20 C L = 6.00 m	38.10

PERI Rental Criteria | APAC

ALUMINUM Beam | AB 16B 240



Aluminum Profile	No.	Description	Article Number
------------------	-----	-------------	----------------

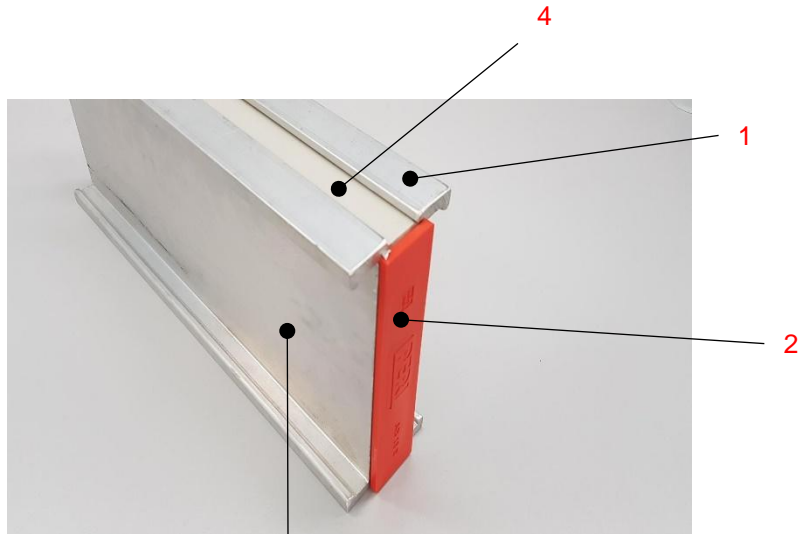

- 1 Flange
- 2 End Cap 239256
- 3 Web
- 4 Nailing Strip

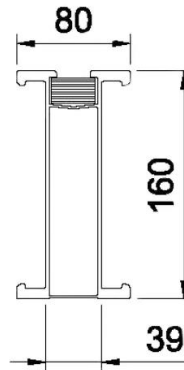

Article No.	Description	Weight (kgs)
039175	Alu Beam AB 16 B L = 0.90 m	4.42
039176	Alu Beam AB 16 B L = 1.20 m	5.89
039177	Alu Beam AB 16 B L = 1.50 m	7.37
039178	Alu Beam AB 16 B L = 1.80 m	8.84
039179	Alu Beam AB 16 B L = 2.10 m	10.31
039180	Alu Beam AB 16 B L = 2.40 m	11.78
039181	Alu Beam AB 16 B L = 2.70 m	13.26
039182	Alu Beam AB 16 B L = 3.00 m	14.74
039183	Alu Beam AB 16 B L = 3.30 m	16.2
039184	Alu Beam AB 16 B L = 3.60 m	17.68
039185	Alu Beam AB 16 B L = 3.90 m	19.15
039186	Alu Beam AB 16 B L = 4.20 m	20.62
039187	Alu Beam AB 16 B L = 4.50 m	22.1
039188	Alu Beam AB 16 B L = 4.80 m	23.57
039189	Alu Beam AB 16 B L = 5.10 m	25.04
039190	Alu Beam AB 16 B L = 5.40 m	26.51
039191	Alu Beam AB 16 B L = 5.70 m	27.99
039192	Alu Beam AB 16 B L = 6.00 m	29.46

PERI Rental Criteria | APAC

ALUMINUM Beam | AB 20C , AB16B



Aluminum Profile	Description	Instruction	Billing Condition	Type
	Holes on Profile <ul style="list-style-type: none"> ▪ $\leq 50\text{mm}$ distance (center) Max. Hole Dia. 10mm (min. 100mm space between hole) 			
	<ul style="list-style-type: none"> ▪ $\geq 50\text{mm}$ distance (center) Max. Hole Dia. 5mm (min. 100mm space between hole) 			
	<ul style="list-style-type: none"> ▪ Exceed Tolerance 			
	<ul style="list-style-type: none"> ▪ Or If resize not Possible 			
	De-nailing			

PERI Rental Criteria | APAC

ALUMINUM Beam | AB 20C , AB16B



Aluminum Profile	Description	Instruction	Billing Condition	Type
------------------	-------------	-------------	-------------------	------

Main Profile Bent

- No dents in profile
≤ Perm. Bending (L/400)
- ≥ Permitted Bending (L/400)

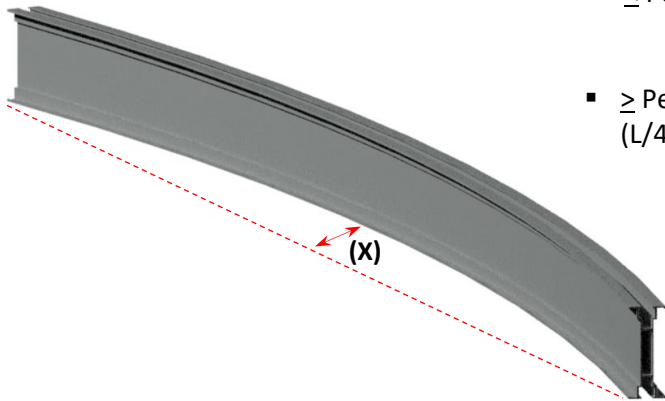

















Description	Tolerance (mm) X = L/400
Alu Beam AB 20 C AB 16 B L = 0.90 m	2
Alu Beam AB 20 C AB 16 B L = 1.20 m	3
Alu Beam AB 20 C AB 16 B L = 1.50 m	4
Alu Beam AB 20 C AB 16 B L = 1.80 m	5
Alu Beam AB 20 C AB 16 B L = 2.10 m	5
Alu Beam AB 20 C AB 16 B L = 2.40 m	6
Alu Beam AB 20 C AB 16 B L = 2.70 m	7
Alu Beam AB 20 C AB 16 B L = 3.00 m	8
Alu Beam AB 20 C AB 16 B L = 3.30 m	8
Alu Beam AB 20 C AB 16 B L = 3.60 m	9
Alu Beam AB 20 C AB 16 B L = 3.90 m	10
Alu Beam AB 20 C AB 16 B L = 4.20 m	11
Alu Beam AB 20 C AB 16 B L = 4.50 m	11
Alu Beam AB 20 C AB 16 B L = 4.80 m	12
Alu Beam AB 20 C AB 16 B L = 5.10 m	13
Alu Beam AB 20 C AB 16 B L = 5.40 m	14
Alu Beam AB 20 C AB 16 B L = 5.70 m	14
Alu Beam AB 20 C AB 16 B L = 6.00 m	15

PERI Rental Criteria | APAC

ALUMINUM Beam | AB 20C , AB16B











Aluminum Profile	Description	Instruction	Billing Condition	Type
	Bent on Flange			
	<ul style="list-style-type: none"> ▪ ≤ 5 mm 			
	<ul style="list-style-type: none"> ▪ Or ≥ 5 mm 			
	<ul style="list-style-type: none"> ▪ Or If resize not Possible 			
	Cut in Profile			
	<ul style="list-style-type: none"> ▪ Resize to others accepted lengths. 			
	<ul style="list-style-type: none"> ▪ Or If resize not Possible 			

PERI Rental Criteria | APAC

ALUMINUM Beam | AB 20C , AB16B













Aluminum Profile	Description	Instruction	Billing Condition	Type
	<p>Compression on Flange</p>			
	<p>Profile End Crushed</p> <ul style="list-style-type: none"> Resize to others accepted lengths. 			

PERI Rental Criteria | APAC









ALUMINUM Beam | AB 20C , AB16B

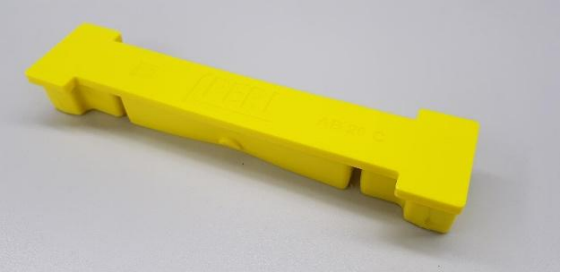

Aluminum Profile	Description	Instruction	Billing Condition	Type
	<p>Profile Web Buckling</p> <ul style="list-style-type: none"> ▪ ≥ 3 mm 			
	<p>Profile Dent</p> <ul style="list-style-type: none"> ▪ ≤ 5 mm 			
	<ul style="list-style-type: none"> ▪ ≥ 5 mm 			

PERI Rental Criteria | APAC
ALUMINUM Beam | AB 20C , AB16B













Aluminum Profile	Description	Instruction	Billing Condition	Type
	<p>End Cap Missing</p> <p>AB 20C</p> <ul style="list-style-type: none"> Replace Missing Parts Art. 239255 			
	<p>End Cap Missing</p> <p>AB 16B</p> <ul style="list-style-type: none"> Replace Missing Parts Art. 239256 			

PERI Rental Criteria | APAC

ALUMINUM Beam | AB 20C , AB16B



Aluminum Profile	Description	Instruction	Billing Condition	Type
	<p>Heavy Concrete Soiling</p>			
	<p>Profile altered by unauthorized cut</p> <ul style="list-style-type: none"> ▪ Resize to others accepted lengths. ▪ Or If resize not Possible 	 	 	 

PERI Rental Criteria | APAC

ALUMINUM Beam | AB 20C , AB16B



Icon	Significance	Icon	Significance	Icon	Significance
	Not OK – material is scrap		Billing necessary (customer)		Optical damage
	OK—material stays in rental park		No Billing necessary		Functional damage
	Scrap material—it's not permitted to hand out the material because of safety aspects		Shorten material		Functional damage—it's not permitted to hand out the material
	Repair according to Instruction		Mark material		Static damage—it's not permitted to hand out the material
	Fix material cold- Afterwards check weld seams and bordering components		Replace damaged material		
	Repair after local economic efficiency calculation		Replace missing material		
	Clean material				