

PERI Rental Criteria

ALPHAKIT

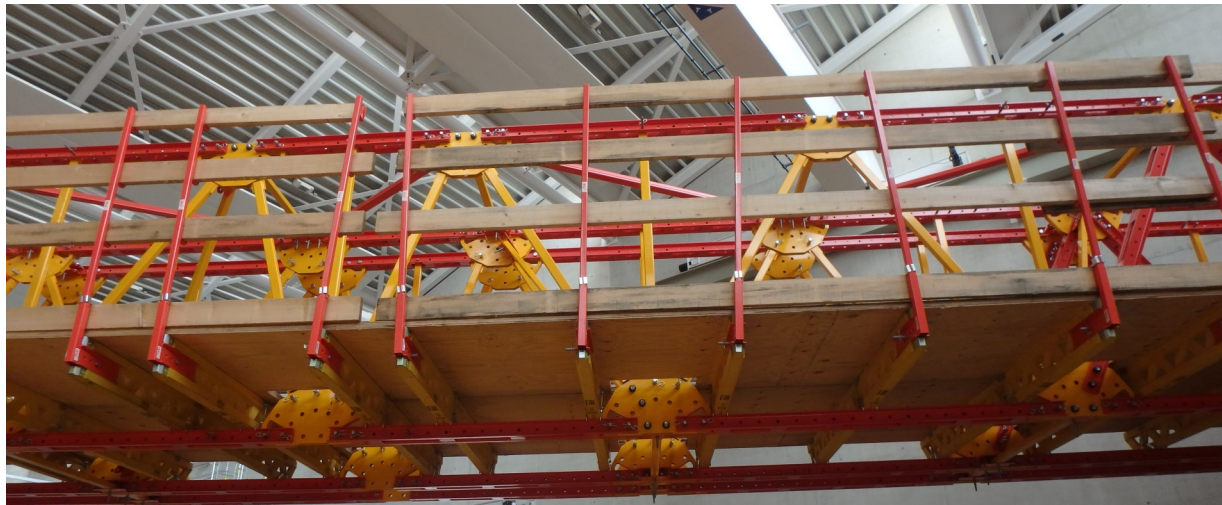

Contact

PERI GmbH
Formwork Scaffolding
Engineering
 P.O. Box 1264
 89264 Weissenhorn, Germany
 Phone +49 (0) 7309.950-0
 Fax +49 (0) 7309.951-0
 rental-criteria@peri.de

Content	Page	Changes made	Date Initial	Page
Diagonal	2	New Version	08/2016 fw	
Horizontal Posts	6	Main Beam Bracket added	08/2019 fw	9
Steel Waler	7	Base Spindle added	10/2019 fw	28
Main Beam	8	Truss Diagonal 2 added	04/2021 fw	18
Main Beam Bracket	9	New articles added	03/2022 fw	31-36
Assembly Parts	10	Chord Note bent added	03/2023 fw	12
Glossary	35	Articles removed	03/2023 fw	35-36

PERI Rental Criteria

ALPHAKIT



Diagonal	No.	Name	Article number
----------	-----	------	----------------

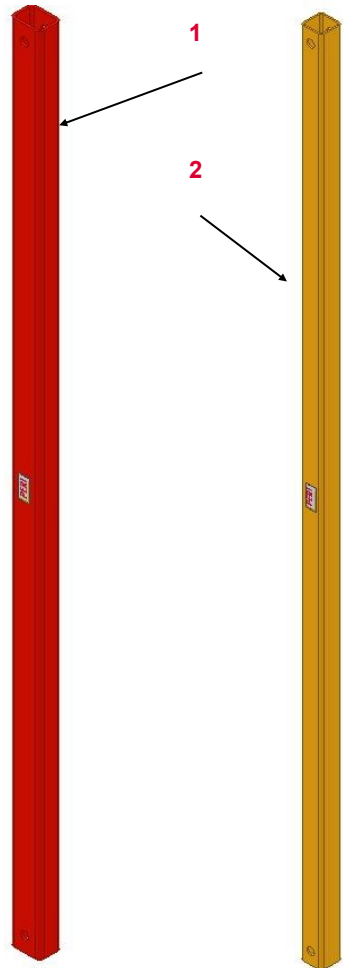

1	Diagonal-6
2	Diagonal-4

Valid for

Diagonal-6 150/212 Alpha	130090
Diagonal-6 150/262 Alpha	130079
Diagonal-6 150/162 Alpha	130071
Diagonal-6 100/262 Alpha	130063
Diagonal-6 100/212 Alpha	130061
Diagonal-6 100/162 Alpha	130059
Diagonal-4 150/136 Alpha	130055
Diagonal-4 150/162 ATS	130053
Diagonal-4 150/186 Alpha	130051
Diagonal-4 150/262 Alpha	130049
Diagonal-4 150/212 ATS	130047

Diagonal	Description	Instruction	Billing Condition	Type
	Diagonal bent			
	■ ≤ permitted bent (l/500)			
	■ Or > permitted bent (l/500)			
	Permitted bent			
	Diagonal-6 150/212 Alpha	5 mm		
	Diagonal-6 150/262 Alpha	6 mm		
	Diagonal-6 150/162 Alpha	4 mm		
	Diagonal-6 100/262 Alpha	6 mm		
	Diagonal-6 100/212 Alpha	5 mm		
	Diagonal-6 100/162 Alpha	4 mm		
Diagonal-4 150/136 Alpha	4 mm			
Diagonal-4 150/162 ATS	4 mm			
Diagonal-4 150/186 Alpha	5 mm			
Diagonal-4 150/262 Alpha	6 mm			
Diagonal-4 150/212 ATS	5 mm			

Diagonal	Description	Instruction	Billing Condition	Type
	Dent in Profile			
	<ul style="list-style-type: none"> ■ ≤ 5 mm depth and edges not affected 			
<ul style="list-style-type: none"> ■ Or > 5 mm depth 				
			<ul style="list-style-type: none"> ■ Or edges affected 	
	Profile end deformed			
	<ul style="list-style-type: none"> ■ If possible 			
			<ul style="list-style-type: none"> ■ Or if not possible 	

Truss Diagonal 212; 262 (130098; 130122)	Description	Instruction	Billing Condition	Type
	<p>Profile bent</p> <ul style="list-style-type: none"> ■ > 5 mm 			
	<p>Bracket bent</p> <ul style="list-style-type: none"> ■ If possible ■ Or if not possible ■ Or crack in welding 	 	088244 	

Horizontal post



Valid for

Horizontal Post 37.5 Alpha	130085
Horizontal Post 50 Alpha	130067
Horizontal Post 75 Alpha	130083
Horizontal Post 100 Alpha	130069
Horizontal Post 150 Alpha	130065

Damage	Description	Instruction	Billing Condition	Type
--------	-------------	-------------	-------------------	------

Profile bent



- > 5 mm



Profile end bent



- If possible
- Or if not possible



088244





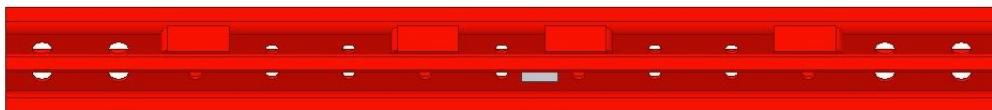

Steel Waler



Valid for

Steel Waler 162 Alpha	129877
Steel Waler 212 Alpha	129874
Steel Waler 262 Alpha	129871

Damage	Description	Instruction	Billing Condition	Type
--------	-------------	-------------	-------------------	------

	Profile end bent		 088244	
	<ul style="list-style-type: none"> ■ If possible ■ Or if not possible 			

	Profile bent	 		
	<ul style="list-style-type: none"> ■ > 5 mm 			

Main Beam



Valid for

Main Beam 300 Alpha	130042
Main Beam 500 Alpha	130039
Main Beam 1000 Alpha	130036

Damage

Description

Instruction







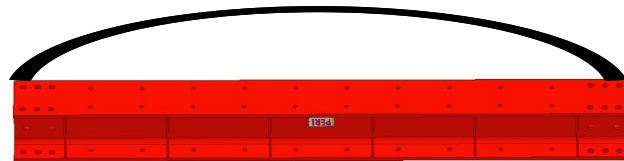

Billing Condition

Type

Main Beam bent

- > 15 mm (L/500)



Main Beam Bracket (132622)	Description	Instruction	Billing Condition	Type
	<p>Pin Stranded wire missing</p>	 <p>113247 (Pin) 127303 (Stranded wire)</p>		
	<p>Bracket bent</p>			
	<ul style="list-style-type: none"> ■ If possible 			
	<ul style="list-style-type: none"> ■ Or if not possible 			

PERI Rental Criteria

ALPHAKIT











Prop Base ATS (130150)	Description	Instruction	Billing Condition	Type	
	Connection bracket bent				
	■ If possible			088244	
	■ Or if possible				
	■ Or crack in welding				
	Foot plate bent			088244	

PERI Rental Criteria

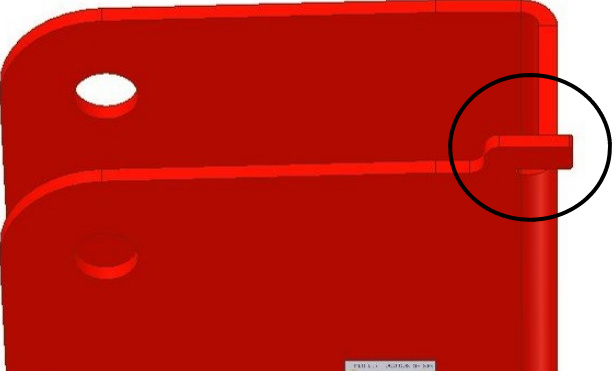
ALPHAKIT





















Bracing Connector ATG; 75 (130124;130081)	Description	Instruction	Billing Condition	Type	
	Bent			088244	
	Nose bent			088244	

PERI Rental Criteria

ALPHAKIT

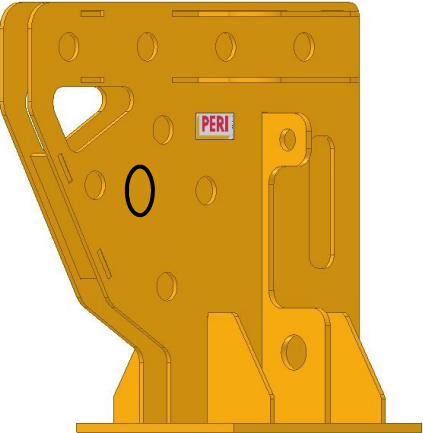

Chord note ATG (130119)	Description	Instruction	Billing Condition	Type	
	Bracket bent			088244	
	Ground plate bent	<ul style="list-style-type: none"> ■ ≤ 5mm 			
	<ul style="list-style-type: none"> ■ Or > 5 mm 				

Support Node (130115)	Description	Instruction	Billing Condition	Type
	Bracket bent		 088244	
	Dents in profile	<ul style="list-style-type: none"> ■ > 5 mm depth 		 

PERI Rental Criteria

ALPHAKIT



Vertical Connector ATS (130108)	Description	Instruction	Billing Condition	Type
---------------------------------	-------------	-------------	-------------------	------



Brackets bent



088244









Profile end bent

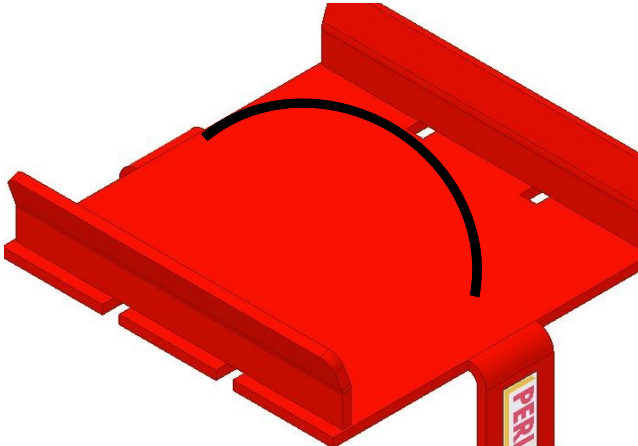

088244



Support Calotte ATG (130103)	Description	Instruction	Billing Condition	Type
	Plate bent	<ul style="list-style-type: none"> ■ If possible ■ Or if not possible 		
	088244			
	Base plate bent			
	<ul style="list-style-type: none"> ■ > 5 mm 			

PERI Rental Criteria

ALPHAKIT



Support Adapter ATG (130094)	Description	Instruction	Billing Condition	Type
------------------------------	-------------	-------------	-------------------	------

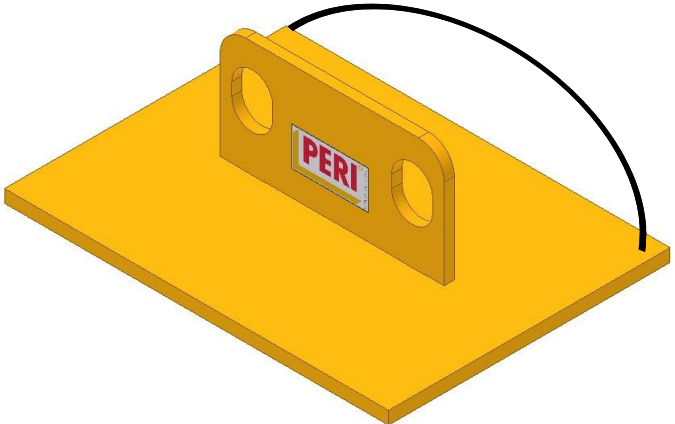

Base plate bent

■ > 5 mm



Support plate bent



088244



PERI Rental Criteria

ALPHAKIT



Truss Diagonal ATG (130088)	Description	Instruction	Billing Condition	Type
-----------------------------	-------------	-------------	-------------------	------



Tube bent

■ > 5 mm



Bracket bent



088244



PERI Rental Criteria

ALPHAKIT











Truss Diagonal ATG –2 (137201)	Description	Instruction	Billing Condition	Type
	Plaid bent	<ul style="list-style-type: none"> ■ If possible 		
	<ul style="list-style-type: none"> ■ Or if not possible 			
	<ul style="list-style-type: none"> ■ Or crack in welding 			

PERI Rental Criteria

ALPHAKIT



H- Load Tie Yoke DW 15 (130032)	Description	Instruction	Billing Condition	Type
	Thread			
	<ul style="list-style-type: none"> <li data-bbox="875 571 972 596">■ Soiled <li data-bbox="875 711 1155 737">■ Or thread not moveable 	 	 	 
	Bent			088244 

H- Load Connector ATG (130029)	No.	Name	Article number
--------------------------------	-----	------	----------------

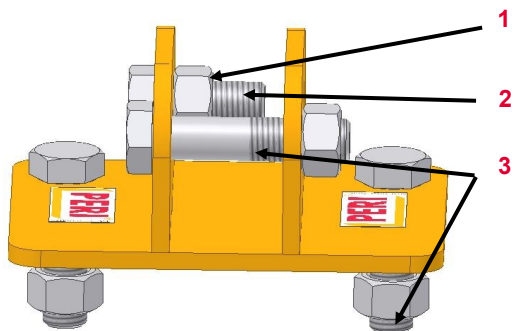

1	Sechskantmutter M 20	710334
2	Schraube M 20x 50	780357
3	Schraube M 20x 70	721912

Schaden	Description	Instruction	Billing Condition	Type
---------	-------------	-------------	-------------------	------

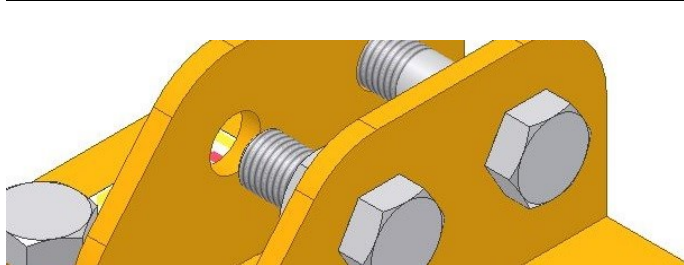

Bracket bent



088244

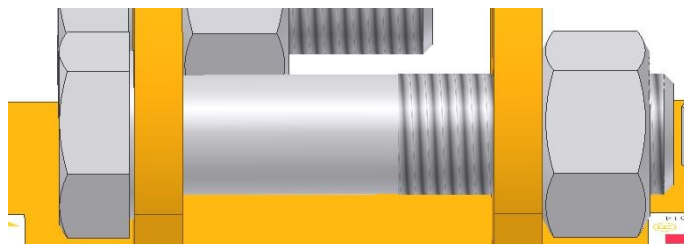

Screw | nut

- Missing
- Or damaged



088024



088024



PERI Rental Criteria

ALPHAKIT



Head Spindle ATS (130144)	No.	Name	Article number
---------------------------	-----	------	----------------

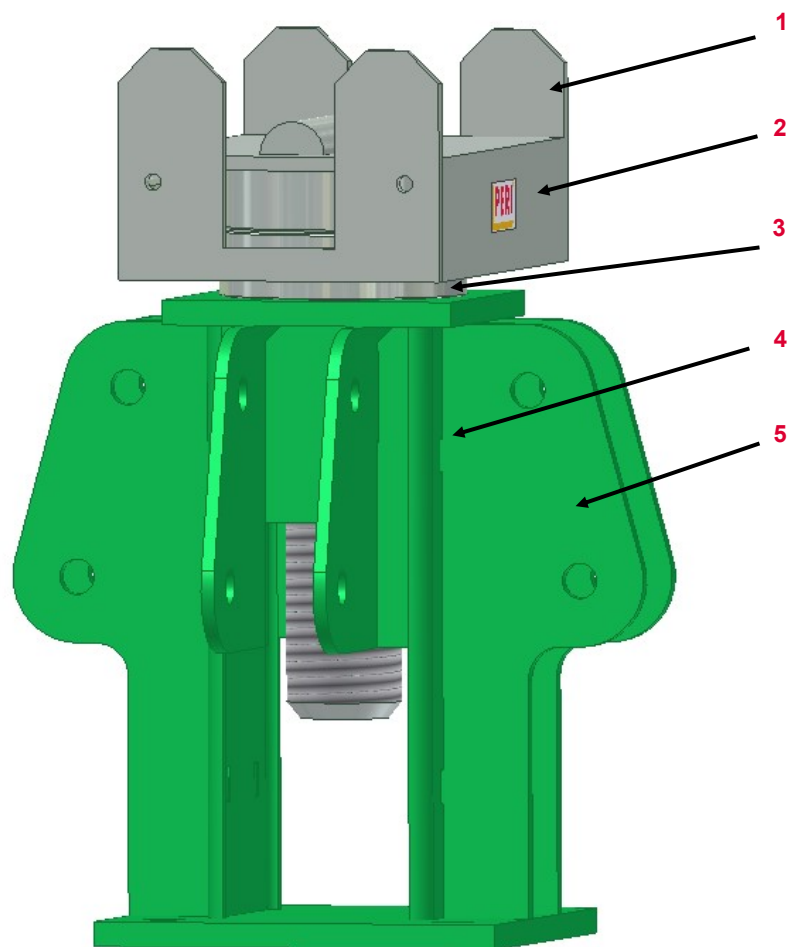

1	Side profile	
2	Spindle	130134
3	Nut TR 70	130128
4	Head Spindle	
5	Connection brackets	

Head Spindle ATS	Description	Instruction	Billing Condition	Type
	Side profile bent			
	■ If possible			
	Connection bracket bent			
	■ Or if not possible			
	Spindle useless			
	130134 (Spindle)			

PERI Rental Criteria

ALPHAKIT



Ladder Connector 60/60 ATS (130077)

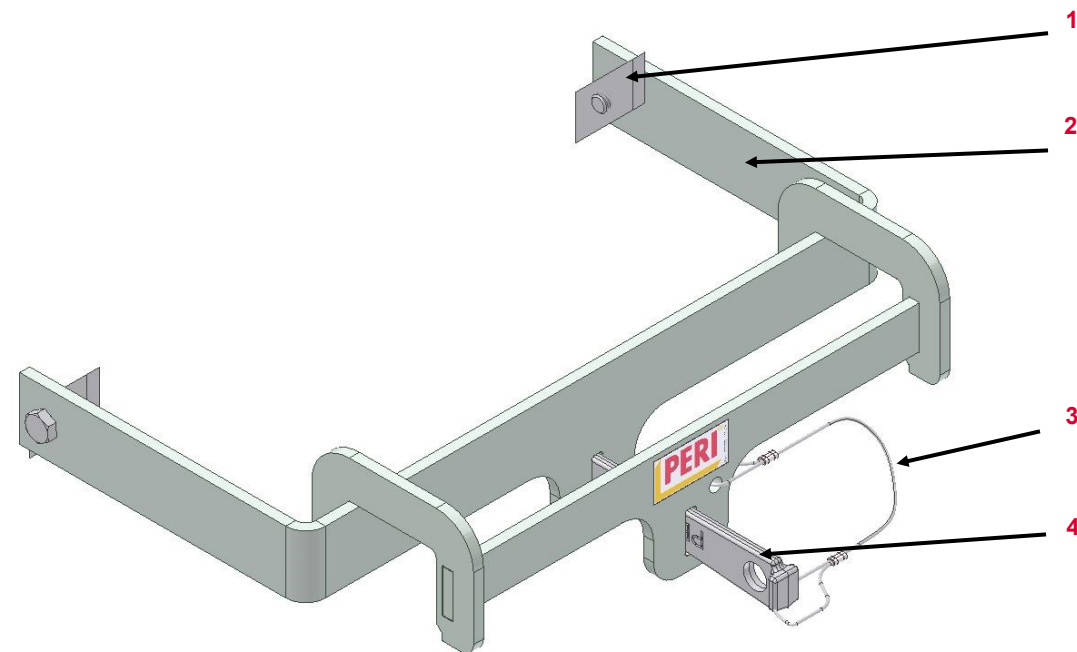











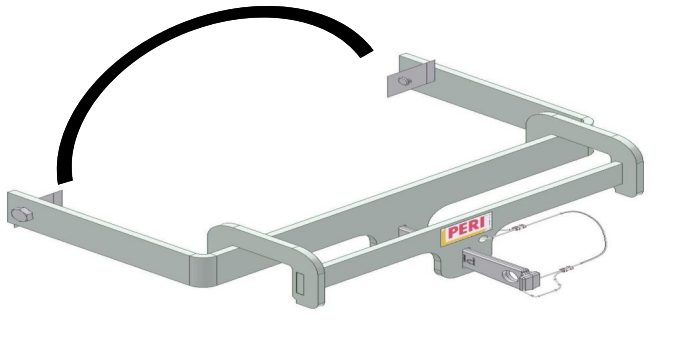

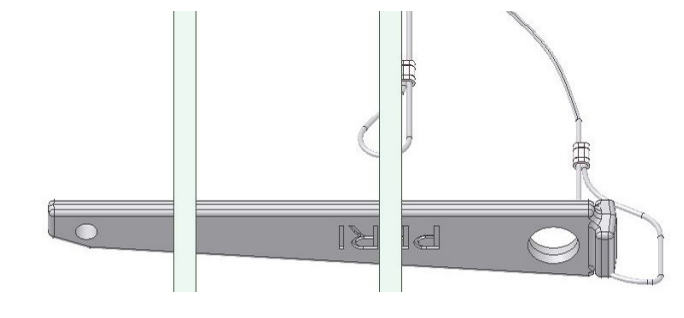

No.	Name	Article number
-----	------	----------------

1	Fixing plate	701763
2	Bracket	
3	Chain	127303
4	PERI Wedge	024250

PERI Rental Criteria

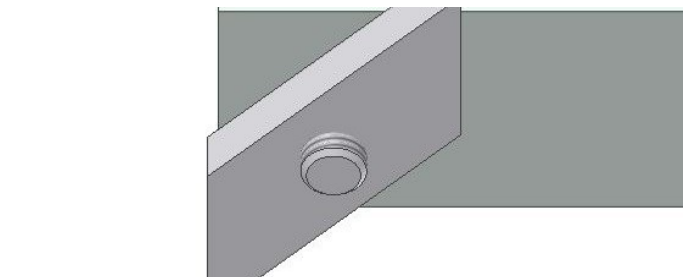
ALPHAKIT



Ladder Connector (130077)	Description	Instruction	Billing Condition	Type
	<p>Bent</p> <ul style="list-style-type: none"> ■ If possible ■ Or if not possible 	<p> 088244</p> <p></p>	<p> 088244</p> <p></p>	<p></p> <p></p>
	<p>Wedge missing</p>	<p> 024250 (Wedge) 127303 (Chain) 127302 (Ferrule)</p>	<p></p>	<p></p>
	<p>Fixing plate bent useless</p>	<p> 701763</p>	<p></p>	<p></p>

PERI Rental Criteria

ALPHAKIT



Scaffold Tube Adapter Ø 48 Alpha (130045)	No.	Name	Article number
---	-----	------	----------------

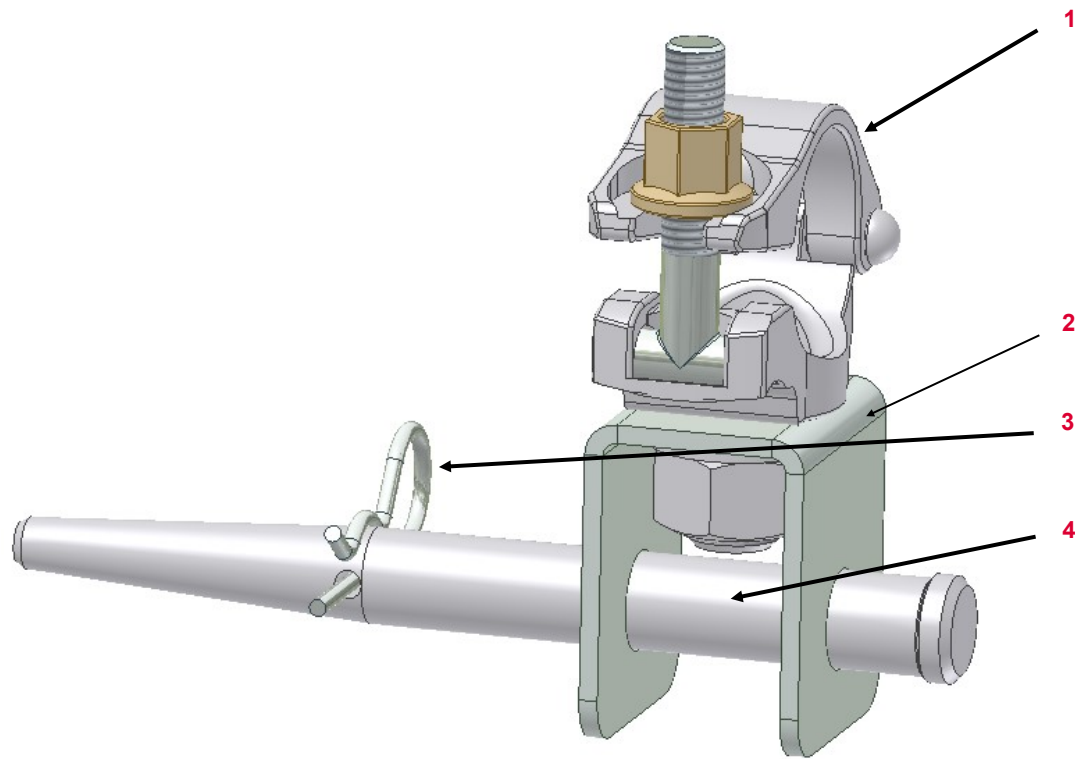









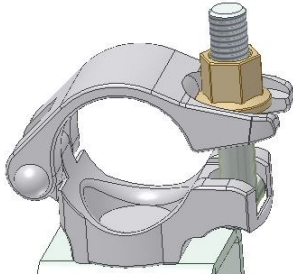



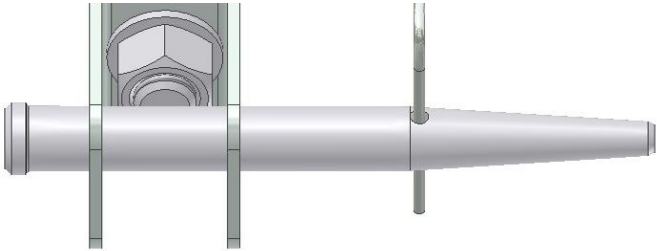





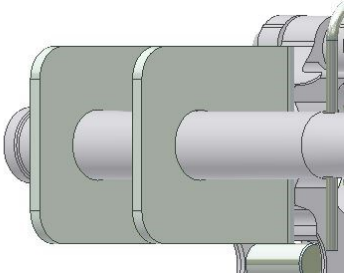







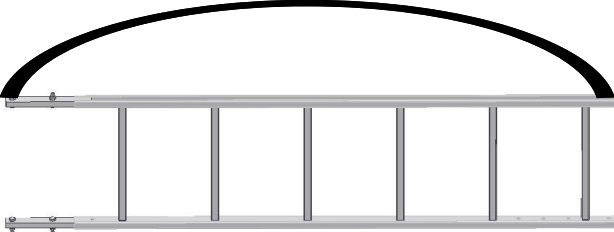

1	Coupling	017040
2	Base material	
3	Cotter Pin 4/1	018060
4	Fit Bolt	104031

PERI Rental Criteria

ALPHAKIT

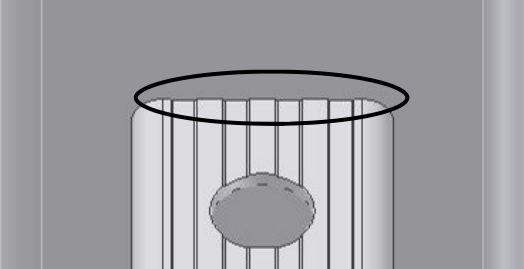

Scaffold Tube Adapter	Description	Instruction	Billing Condition	Type
	Coupling missing useless	 017040 (Coupling)		
	<ul style="list-style-type: none"> ■ Missing 	 104031 (Fit Bolt) 018060 (Cotter Pin)		
	<ul style="list-style-type: none"> ■ Or useless 	 104031 (Fit Bolt) 018060 (Cotter)		
	<ul style="list-style-type: none"> ■ If possible 		 088244	
	<ul style="list-style-type: none"> ■ Or if not possible 			

Ladder 180/6 051410 Ladder (103724)	Description	Instruction	Billing Condition	Type
	<p>Bent</p> <ul style="list-style-type: none"> ■ > 5 mm 			
	<p>Kink in ladder rung</p>			
	<p>Crack in welding</p>			

Support Node (130332)	Description	Instruction	Billing Condition	Type
-----------------------	-------------	-------------	-------------------	------

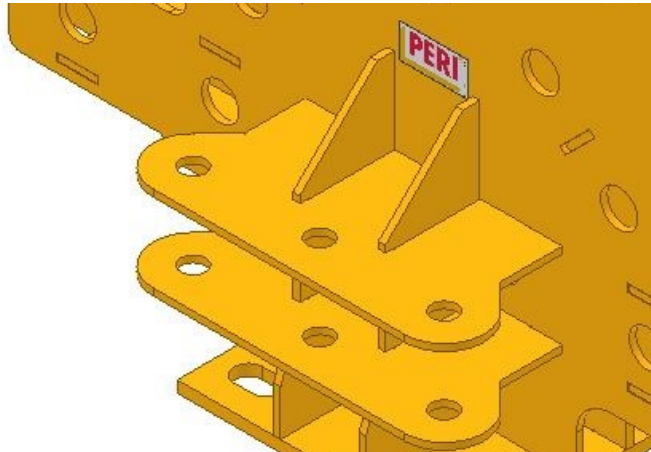

Bracket bent



088244

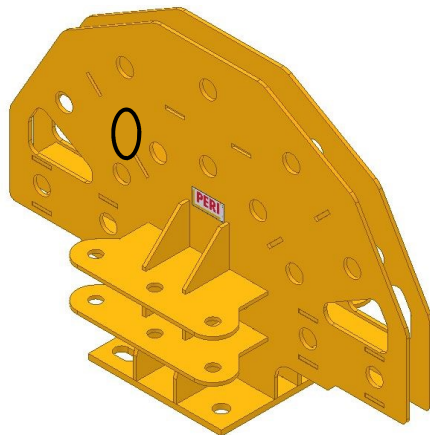

Dent in profile

■ >5 mm depth



PERI Rental Criteria

ALPHAKIT









Base Spindle ATS (135438)	Description	Instruction	Billing Condition	Type
	Base plate bent			
	<ul style="list-style-type: none"> ■ If possible 			
<ul style="list-style-type: none"> ■ Or if not possible 	<ul style="list-style-type: none"> Base plate right (135437) Base plate left (135435) 			
	Spindle damaged (function not given)			



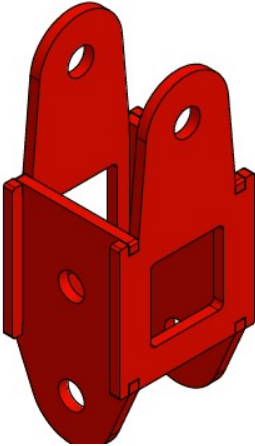







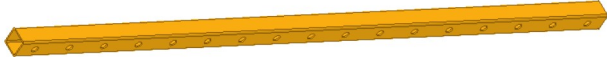

PERI Rental Criteria

ALPHAKIT

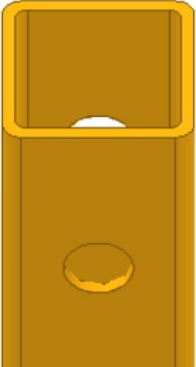

Base Spindle ATS (135438)	Description	Instruction	Billing Condition	Type
	Grease on spindle			

Bracing Connector VARIOKIT (137531)	Description	Instruction	Billing Condition	Type
	<p>Plaids bent</p>	<ul style="list-style-type: none"> <li data-bbox="875 568 1010 593">■ If possible <li data-bbox="875 711 1084 737">■ Or if not possible 		
				







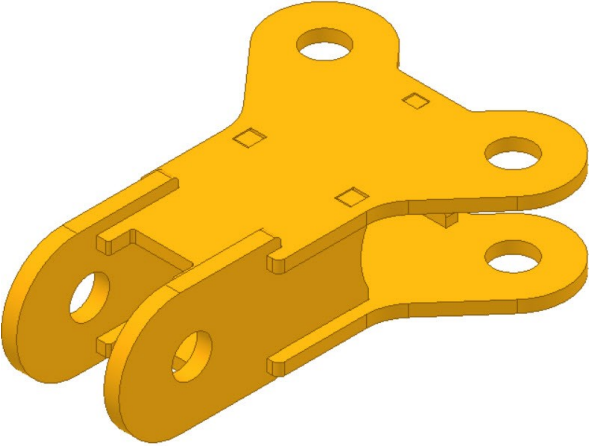

Bracing Cross Bar VARIOKIT (137533)	Description	Instruction	Billing Condition	Type
	Cross bar bent	<ul style="list-style-type: none"> <li data-bbox="875 571 1010 596">■ If possible 		
	<ul style="list-style-type: none"> <li data-bbox="875 711 1084 737">■ Or if not possible 			
	Tube squeezed	<ul style="list-style-type: none"> <li data-bbox="875 1088 1010 1114">■ If possible 		
	<ul style="list-style-type: none"> <li data-bbox="875 1232 1084 1257">■ Or if not possible 			

PERI Rental Criteria

ALPHAKIT



















Bracing Shoe VARIOKIT (137527)	Description	Instruction	Billing Condition	Type
	<p>Plaids bent</p>			
	<ul style="list-style-type: none"> ■ If possible 			
<ul style="list-style-type: none"> ■ Or if not possible 				

Y-Adapter VARIOKT (137522)	Description	Instruction	Billing Condition	Type
	<p>Plaids bent</p> <ul style="list-style-type: none"> ■ If possible ■ Or if not possible 	<p>    </p>	<p>   </p>	<p>   </p>

PERI Rental Criteria

Glossary Icons



Icon	Significance	Icon	Significance	Icon	Significance
	Not Ok– material is scrap		Billing necessary (customer)		Optical damage
	OK– material stays in rental park		No Billing necessary		Functional damage
	Scrap material– it's not permitted to hand out the material because of safety aspects		Shorten material		Functional damage— it's not permitted to hand out the material
	Repair according to instruction		Mark material		Static damage— it's not permitted to hand out the material
	Fix material cold—Afterwards check weld seams and bordering components		Replace damaged material		
	Repair after local economic efficiency calculation		Replace missing material		
	Clean material				