

PERI Rental Criteria

VRB Heavy-Duty Truss Girder

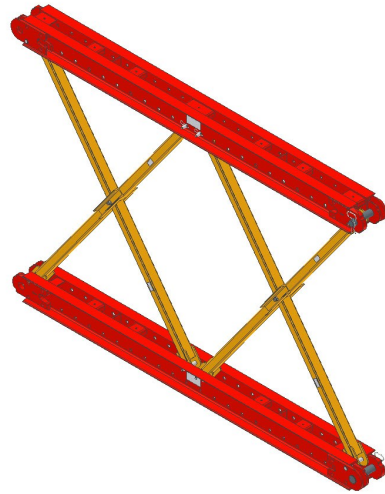

Contact

PERI GmbH
Formwork Scaffolding
Engineering
 P.O. Box 1264
 89259 Weissenhorn, Germany
 Phone +49 (0) 7309.950-0

Content	Page
Supporting frame	2
VRB Supporting frame VRB	5
Coupling frame	8
Standard frame VRB	11
Horizontal bearing	14
Bracing connection VRB	15
Vertical brace connection	16
Main beam VRB	17
Horizontal Bearing-2	18

Changes	Date Initial	Page
New version	04/2016 fw	
New damages at frames added	07/2021 fw	4;10; 13
Horizontal Bearing-2 added	03/2023 fw	18

PERI Rental Criteria

VRB Heavy-Duty Truss Girder



Supporting frame VRB	No.	Description	Article number
----------------------	-----	-------------	----------------

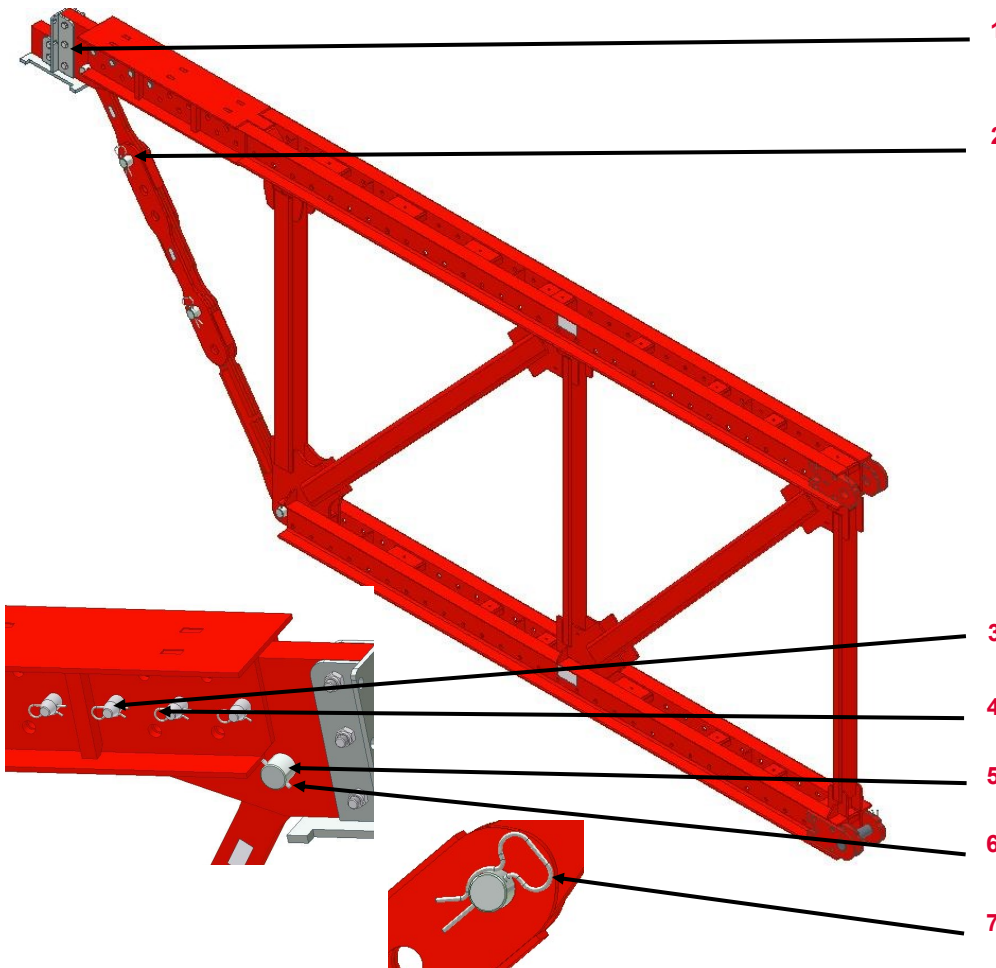











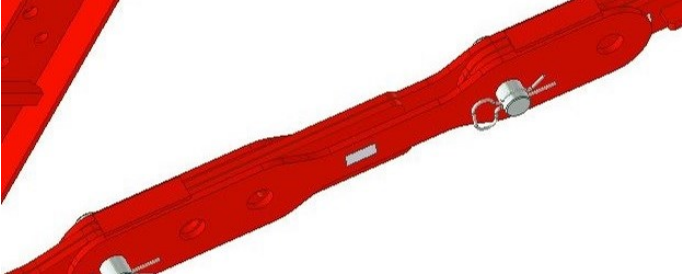

1	„Teleskopkastenschuh“	128084
2	Bolt	113625
3	Fit bolt D30	125347
4	Cotter pin 4/1	018060
5	Bolt D50	113626
6	Dowel pin 8x70	770013
7	Cotter pin 6-1	125356

Valid for article	Article number
Supporting frame 5,25 m VRB	114166
Supporting frame 6,0 m VRB	109469

PERI Rental Criteria

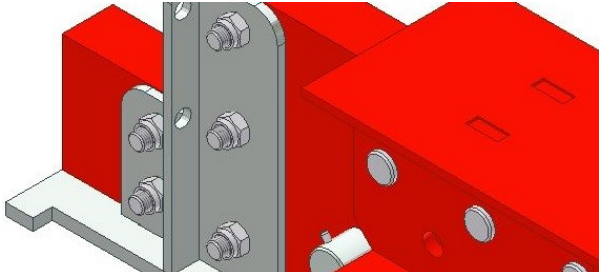
VRB Heavy-Duty Truss Girder





















Supporting frame VRB	Description	Instruction	Billing Instruction	Type
	Tendon bent / defect	 Tendon (126547)		
	Dent on the top and bottom flanges			
	„Teleskopkastenschuh“ bent / ripped	 „Teleskopkastenschuh“ (128084)		

PERI Rental Criteria

VRB Heavy-Duty Truss Girder



Supporting frame VRB	Description	Instruction	Billing Instruction	Type
	Dent in tube <ul style="list-style-type: none"> ■ ≤ 10 mm depth and edges of tube not affected 	 		
	<ul style="list-style-type: none"> ■ Or > 10 mm depth 			
	<ul style="list-style-type: none"> ■ Or edges of tube affected 			
	Chord bent <ul style="list-style-type: none"> ■ $\leq 1/500$ 	 		
	<ul style="list-style-type: none"> ■ Or $> 1/500$ 			

PERI Rental Criteria

VRB Heavy-Duty Truss Girder



Supporting frame VRB (125152)

















No.	Description	Article number
1	Cotter pin 6-1	125356
2	Calotte	125446
3	Fit bolt 21x105	125349
4	Fit bolt 26x105	125345
5	Bolt	113625
6	Dowel pin	770013
7	Bolt	125356
8	Pull bar bearing	125179

PERI Rental Criteria

VRB Heavy-Duty Truss Girder













Supporting frame VRB	Description	Instruction	Billing Instruction	Type
	Broken calotte	 Calotte (125446)		
	Calotte no longer functional	<ul style="list-style-type: none"> ■ If possible  Lubricate afterwards ■ Or if not possible  Calotte (125446) 	<ul style="list-style-type: none">   	<ul style="list-style-type: none">  
	Pull bar bent	 Pull bar (125179)		

PERI Rental Criteria

VRB Heavy-Duty Truss Girder



Supporting frame VRB	Description	Instruction	Billing Instruction	Type
	Bolts / Cotter pins / Dowel pins missing			
	Deformed bolts <ul style="list-style-type: none"> ■ Without rips in the material ■ Or with rip in the material 	 	 	 

Bolt(125356)

PERI Rental Criteria

VRB Heavy-Duty Truss Girder



Coupling frame

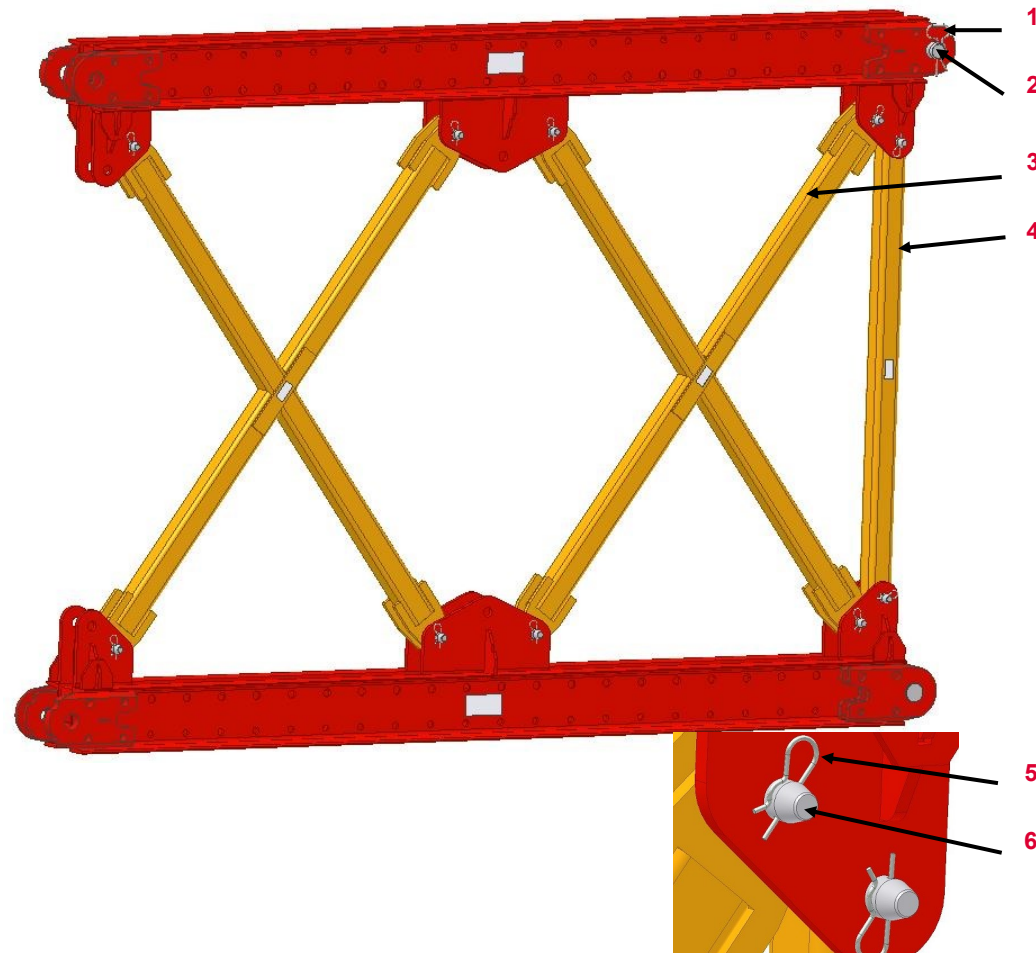













No.	Description	Article number
1	Cotter pin 6-1	125356
2	Bolt D 50 L=250	125355
3	Diagonal brace	125413
4	„Druckpfosten Anfänger“	125413
5	Cotter pin 4/1	018060
6	Fit bolt D 30	125347

Gültig für Artikel	Artikelnummer
Coupling frame 1,5m VRB	125153
Coupling frame 3,0m VRB	125154

PERI Rental Criteria

VRB Heavy-Duty Truss Girder





















Coupling frame	Description	Instruction	Billing Instruction	Type
	Diagonal brace bent / broken	 Diagonal brace(125409)		
	„Druckpfosten“ bent / broken ■ > 3,0 mm (l/500)	 „Druckpfosten“ (125413)		
	Connection of the „Druckpfosten“ is bent			

PERI Rental Criteria

VRB Heavy-Duty Truss Girder



Coupling frame	Description	Instruction	Billing Instruction	Type
	<p>Dent in tube</p> <ul style="list-style-type: none"> ■ ≤ 10 mm depth and edges of tube not affected ■ Or > 10 mm depth ■ Or edges of tube affected 	<ul style="list-style-type: none"> ■   ■  ■  	<ul style="list-style-type: none"> ■  ■  ■  	<ul style="list-style-type: none"> ■  ■  ■ 
	<p>Chord bent</p> <ul style="list-style-type: none"> ■ $\leq 1/500$ ■ Or $> 1/500$ 	<ul style="list-style-type: none"> ■   ■  	<ul style="list-style-type: none"> ■  ■  	<ul style="list-style-type: none"> ■  ■ 

PERI Rental Criteria

VRB Heavy-Duty Truss Girder



Standard frame VRB

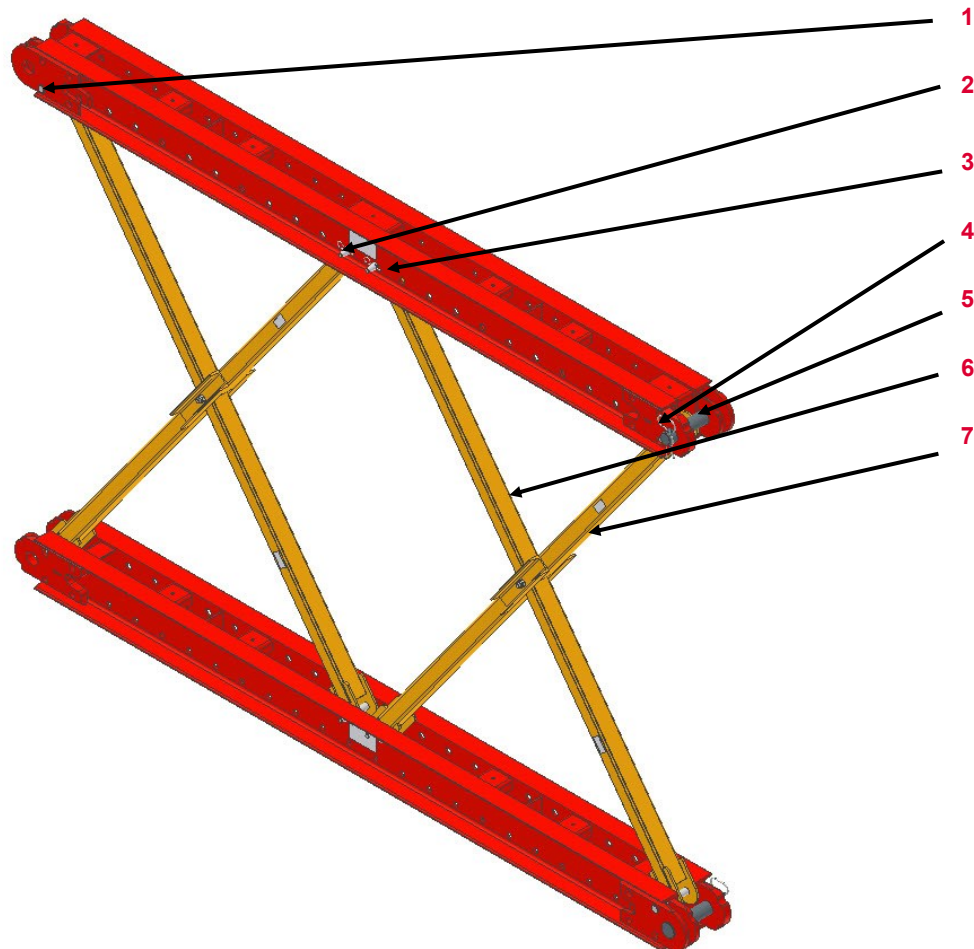







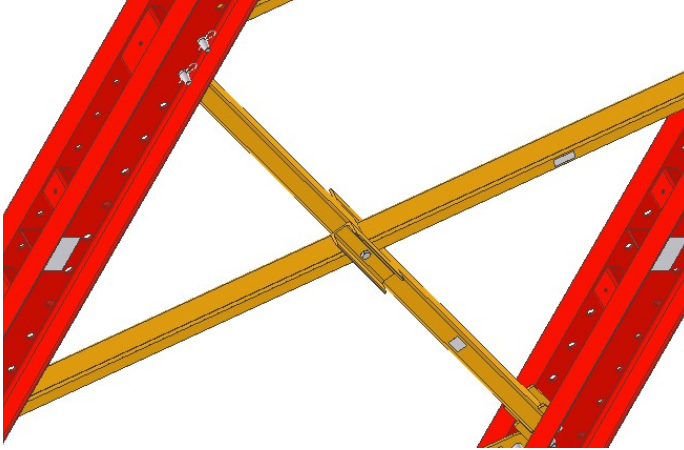

No.	Description	Article number
1	Fit bolt 26x210	125351
2	Fit bolt 26x105	125345
3	Cotter pin	018060
4	Cotter pin 6-1	125356
5	Bolt D 50	125355
6	Diagonal continuous	125381
7	Diagonal discontinuous	125371

Gültig für Artikel	Artikelnummer
Standard frame 3,0 m VRB	127285
Standard frame 4,5 m VRB	125155
Standard frame 6,0 m VRB	125156

PERI Rental Criteria

VRB Heavy-Duty Truss Girder



















Standard frame VRB	Description	Instruction	Billing Instruction	Type
	<p>Diagonals bent</p> <ul style="list-style-type: none"> ■ L > 5 mm (l/500) 	 <p>Diagonal continuous (125381) Diagonal discontinuous (125371)</p>		
	<p>Bolt Cotter pin Dowel pin is missing</p>		 <p>088840</p>	

PERI Rental Criteria

VRB Heavy-Duty Truss Girder



Standard frame VRB	Description	Instruction	Billing Instruction	Type
	<p>Connector bent</p> <ul style="list-style-type: none"> ■ Assembly possible ■ Or assembly not possible 	<ul style="list-style-type: none">    	<ul style="list-style-type: none">   	<ul style="list-style-type: none">  
	<p>Chord bent</p> <ul style="list-style-type: none"> ■ $\leq 1/500$ ■ Or $> 1/500$ 	<ul style="list-style-type: none">    	<ul style="list-style-type: none">   	<ul style="list-style-type: none">  

PERI Rental Criteria

VRB Heavy-Duty Truss Girder



Horizontal bearing VRB (126173)	No.	Description	Article number
---------------------------------	-----	-------------	----------------

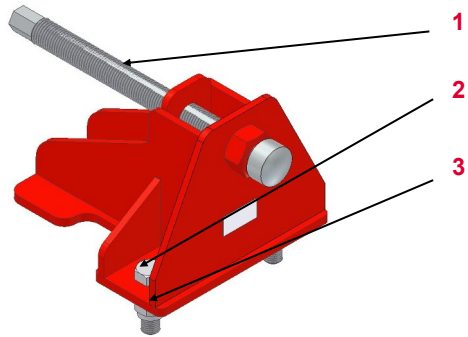

1	Threaded bar	126166
2	Screw	105416
3	Hexagon nut	105032

Damage	Description	Instruction	Billing Instruction	Type
--------	-------------	-------------	---------------------	------



Threaded bar

- Soiled
- Or bent



Base body is bent

- If possible
- Or if not possible



PERI Rental Criteria

VRB Heavy-Duty Truss Girder



Brace connection VRB (125764)	No.	Description	Article number
-------------------------------	-----	-------------	----------------

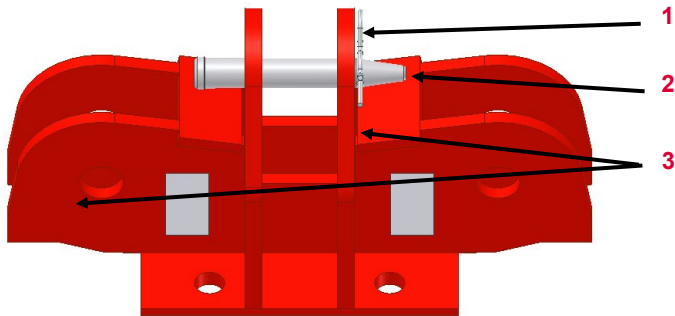

1	Cotter pin	018060
2	Fit bolt	125349
3	Connection lug	

Damage	Description	Instruction	Billing Instruction	Type
--------	-------------	-------------	---------------------	------



Connection lug is bent



Sleeves compressed | broken



PERI Rental Criteria

VRB Heavy-Duty Truss Girder



Vertical brace connection (125770)	No.	Description	Article number
------------------------------------	-----	-------------	----------------

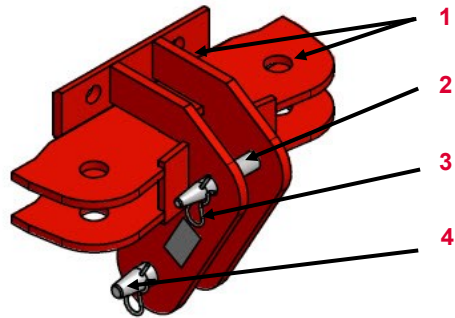

1	Connection lug	
2	Fit bolt 21x105	125349
3	Cotter pin 4/1	018060
4	Fit bolt 26x105	125345

Damage	Description	Instruction	Billing Instruction	Type
--------	-------------	-------------	---------------------	------

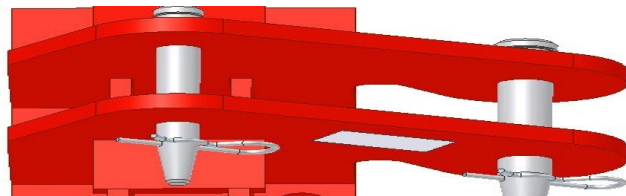

Connection lug is bent



PERI Rental Criteria

VRB Heavy-Duty Truss Girder



Main beam VRB	Description	Instruction	Billing Instruction	Type
---------------	-------------	-------------	---------------------	------

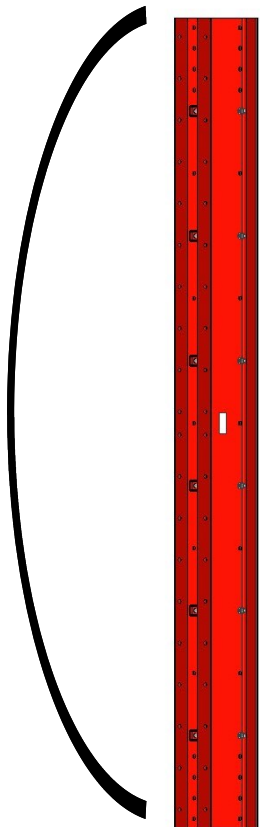

Main beam is bent

■ ≤ permitted bent (l/500)



■ Or > permitted bent (l/500)



Article	Article number	Permitted bent
Main beam 350 VRB	126059	7 mm
Main beam 500 VRB	126062	10 mm
Main beam 800 VRB	126065	16 mm

PERI Rental Criteria

VRB Heavy-Duty Truss Girder



Horizontal Bearing-2 VRB (131852)

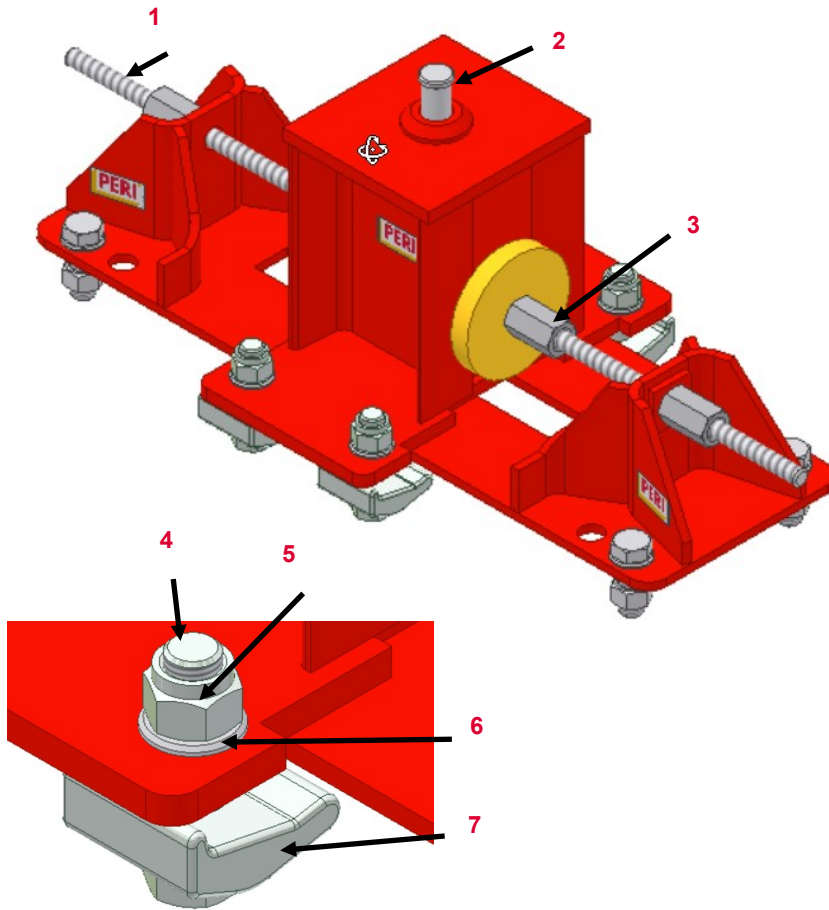









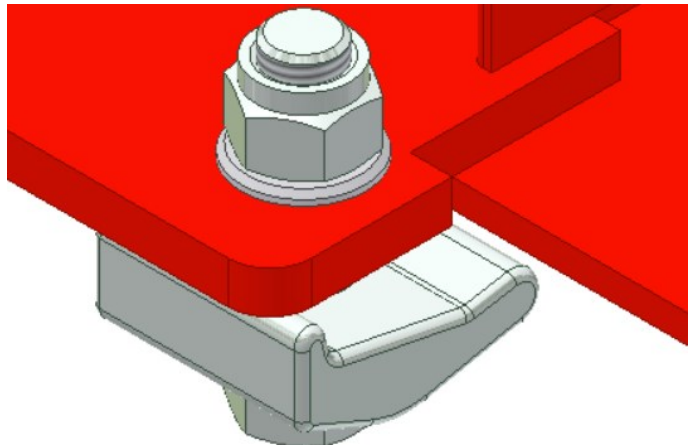

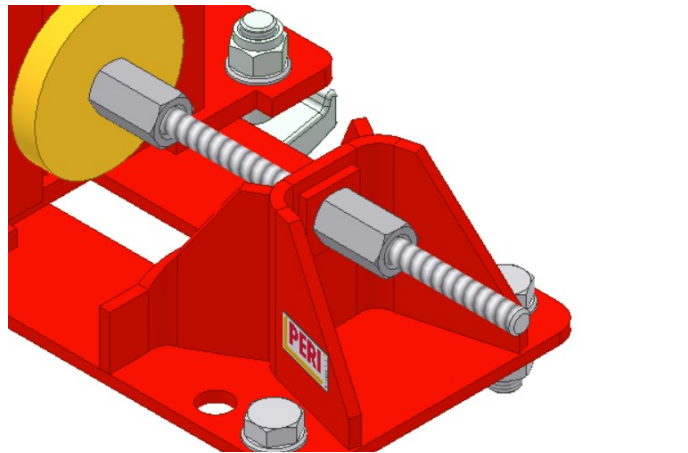

No.	Description	Article number
1	Tie rod	030641
2	Fitting Bolt	125347
3	Nut SW 36	114440
4	Bolt M24x100	135465
5	Nut M24	106803
6	Washer 24-200	132362
7	Clamping plate	127024

PERI Rental Criteria

VRB Heavy-Duty Truss Girder



















Horizontal Bearing- 2 VRB (131852)	Description	Instruction	Billing Instruction	Type
	Clamping Plate Bolt Nut	<ul style="list-style-type: none"> <li data-bbox="873 566 985 598">■ Missing  <li data-bbox="873 710 1176 742">■ Or damaged due to force  	<ul style="list-style-type: none"> <li data-bbox="1803 555 1872 624"> <li data-bbox="1803 694 1872 762"> 	<ul style="list-style-type: none"> <li data-bbox="2087 555 2157 624">
	Tie Rod Nut	<ul style="list-style-type: none"> <li data-bbox="873 1085 985 1117">■ Missing  <li data-bbox="873 1228 1176 1260">■ Or damaged due to force  	<ul style="list-style-type: none"> <li data-bbox="1803 1061 1872 1129"> <li data-bbox="1803 1204 1872 1273"> 	<ul style="list-style-type: none"> <li data-bbox="2087 1061 2157 1129">

PERI Rental Criteria

Glossar Icons



Icon	Significance	Icon	Significance	Icon	Significance
	Not OK – Material is scrap		Billing necessary (customer)		Optical damage
	OK—Material stays in rental park		No billing necessary		Functional damage
	Scrap material— it's not permitted to hand out the material because of safety aspects		Shorten the material		Functional damage– it's not permitted to hand out the material
	Repair according to instruction		Mark the material		Static damage– it's not permitted to hand out the material
	Fix material cold– Afterwards check weld seams and bordering components		Replace damaged material		
	Repair after local economic efficiency calculation		Replace missing material		
	Clean the material				