

# PERI Rental Criteria

## PEP Props



### Contact

**PERI GmbH**  
**Formwork Scaffolding**  
**Engineering**  
 P.O. Box 1264  
 89259 Weissenhorn, Germany  
 Phone +49 (0) 7309.950-0  
 Fax +49 (0) 7309.951-0  
[rental-criteria@peri.de](mailto:rental-criteria@peri.de)

Content	Page
PEP Ergo	2
PEP 20, 30	8
Accessories	13
Glossary	27

Changes	Date   Initial	Page
New Version	09/2015   fw	
20.07.24 Change of values	06/2016   fw	
Several pictures changed	05/2018   fw	
20.07.39 + 40 Head or Base plate cut in added	05/2018   fw	7; 12
20.07 41 Welded Crosshead Handle added	05/2018   fw	23
New repair method für Props	08/2019   fw	3; 9
Damaged welding at Tripod added	03/2020   fw	17
Damage at inner tube added	07/2021   fw	7
Crack at Tension Hoop added	07/2021   fw	17

# PERI Rental Criteria

## PEP Props



PEP ERGO Prop	No.	Name	Article number
---------------	-----	------	----------------

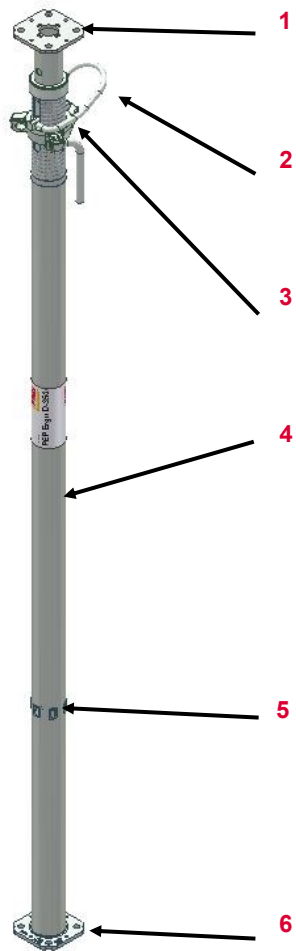











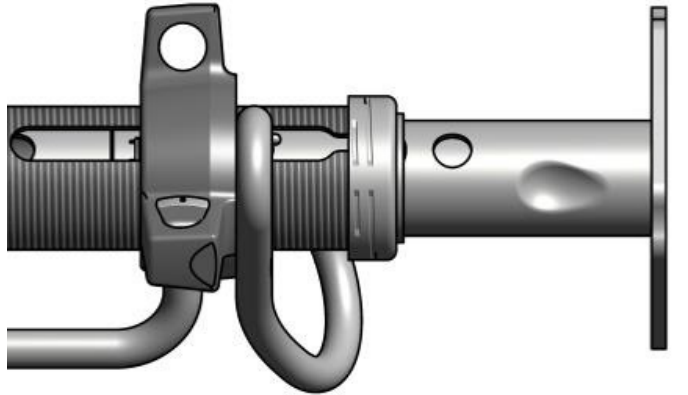

- |   |               |
|---|---------------|
| 1 | Head plate    |
| 2 | G- Hook       |
| 3 | Adjusting nut |
| 4 | Outer tube    |
| 5 | Stamping      |
| 6 | Ground plate  |

Valid for	Article number
Prop PEP ERGO B-300	116780
Prop PEP ERGO B-350	116790
Prop PEP ERGO D-150	117230
Prop PEP ERGO D-250	116770
Prop PEP ERGO D-350	125130
Prop PEP ERGO D-400	125140
Prop PEP ERGO D-500	125150
Prop PEP ERGO E-300	125160
Prop PEP ERGO E-400	125170

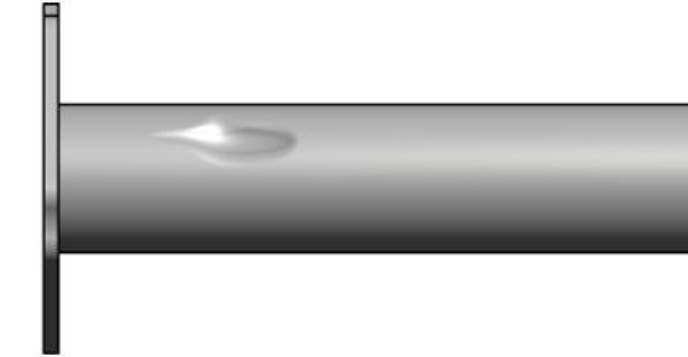
# PERI Rental Criteria

## PEP Props



Prop	Description	Instruction	Billing Condition	Type
	<p><b>Bent inner tube</b></p> <ul style="list-style-type: none"> <li>■ Inner tube not moveable</li> </ul>		 See table (p. 4)	
	<ul style="list-style-type: none"> <li>■ Or depth of bent &gt; 7 mm</li> </ul>		 See table (p. 4)	
	<p><b>Bent outer tube</b></p> <ul style="list-style-type: none"> <li>■ Inner tube not moveable</li> </ul>		 088249	
	<ul style="list-style-type: none"> <li>■ Or depth of bent &gt; 7 mm</li> </ul>		 See table (p. 4)	

# PERI Rental Criteria

## PEP Props











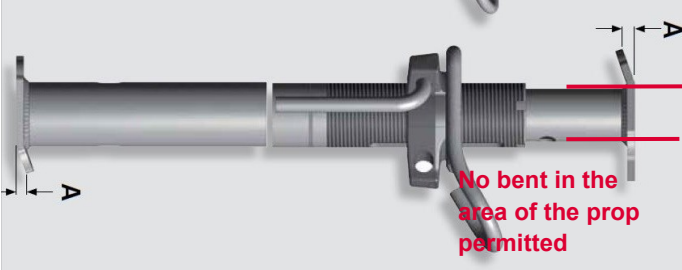









Article	Replace inner tube		Replace outer tube	
	Art.– No. Spare part	Service article number	Art.– No. Spare part	Service article number
PEP ERGO B-300	116786	088719	116788	088710
PEP ERGO B-350	116794	088720	116769	088711
PEP ERGO D-150	117226	088721	117228	088712
PEP ERGO D-250	116778	088722	116789	088713
PEP ERGO D-350	125543	088723	125546	088714
PEP ERGO D-400	125562	088724	125565	088715
PEP ERGO D-500	125581	088725	125584	088716
PEP ERGO E-300	125588	088726	125591	088717
PEP ERGO E-400	125595	088727	125598	088718

# PERI Rental Criteria

## PEP Props



















Damage   Prop	Description	Instruction	Billing Condition	Type
 <p>No bent in the area of the prop permitted</p>	<p><b>Ground or head plate bent</b></p> <ul style="list-style-type: none"> <li>■ &gt; 10 mm</li> </ul>		 088249	
	<p><b>Adjusting nut</b></p> <ul style="list-style-type: none"> <li>■ Nut torn out</li> </ul>	 WI_20_09_PEP_ERGO_nut-exchange_1812_en	 088235	
	<ul style="list-style-type: none"> <li>■ Or crack in adjusting nut</li> </ul>	 WI_20_09_PEP_ERGO_nut-exchange_1812_en	 088235	
	<p><b>G- Hook</b></p> <ul style="list-style-type: none"> <li>■ Missing</li> </ul>	 <ul style="list-style-type: none"> <li>117691 (B-300)</li> <li>117691 (B-350)</li> <li>125554 (E-300)</li> <li>125573 (E-400)</li> <li>117691 (D-150)</li> <li>117691 (D-250)</li> </ul>	 088247	
	<ul style="list-style-type: none"> <li>■ Or function not available</li> </ul>	 <ul style="list-style-type: none"> <li>125536 (D-350)</li> <li>125554 (D-400)</li> </ul>	 088247	

# PERI Rental Criteria

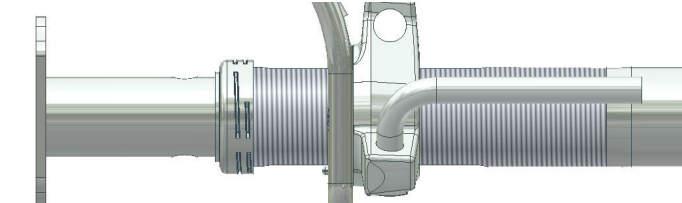
## PEP Props



Prop	Description	Instruction	Billing Condition	Type
	Crack in the welding			
	Stop screw loose/ missing			
	Tube of the props heated			
	Oil or grease at the thread			

# PERI Rental Criteria

## PEP Props



Prop	Description	Instruction	Billing Condition	Type
------	-------------	-------------	-------------------	------

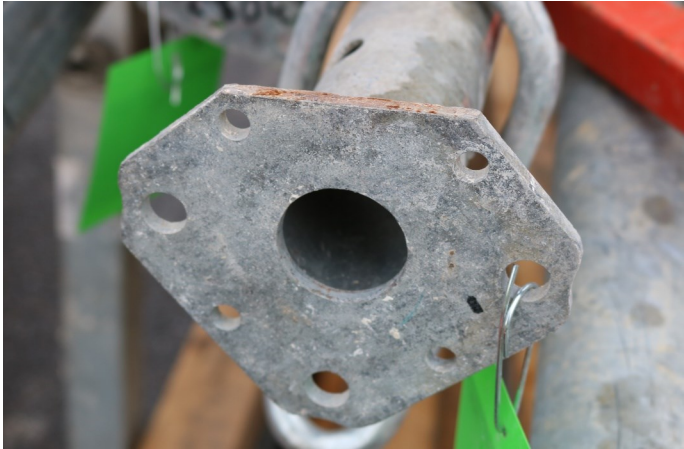

Head or Base Plate cut



WI\_20\_09\_PEP\_ERGO\_tube-exchange\_1812\_en



Hole at inner tube widened



WI\_20\_09\_PEP\_ERGO\_tube-exchange\_1812\_en



# PERI Rental Criteria

## PEP Props



PEP 20, 30 Props	No.	Name	Article number
------------------	-----	------	----------------

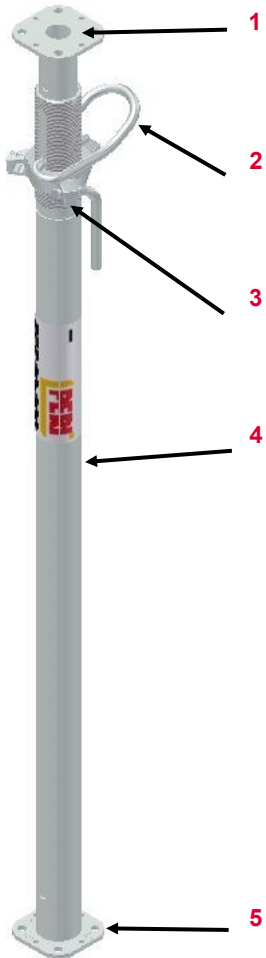

1	Head plate
---	------------

2	G- Hook
---	---------

3	Adjusting nut
---	---------------

4	Outer tube
---	------------









5	Ground plate
---	--------------

Valid for	Article number
Prop PEP 20-300	103058
Prop PEP 20-350	103059
Prop PEP 20-400	103060
Prop PEP 20-500	103061
Prop PEP 30-150	103066
Prop PEP 30-250	103067
Prop PEP 30-300	103062
Prop PEP 30-350	103063
Prop PEP 30-400	103065

# PERI Rental Criteria

## PEP Props























Prop	Description	Instruction	Billing Condition	Type
	<p><b>Dent at the inner tube</b></p> <ul style="list-style-type: none"> <li>Inner tube not moveable</li> </ul>			
	<p><b>Bent outer tube, inner tube not moveable</b></p>	 <p>WI_20_PEP_Dent_PropFIX_1930_en</p>	 <p>088249</p>	

# PERI Rental Criteria

## PEP Props















Prop	Description	Instruction	Billing Condition	Type
	<p><b>Ground or head plate bent</b></p> <ul style="list-style-type: none"> <li>■ &gt; 10 mm</li> </ul>		 088249	
	<p><b>Adjusting nut</b></p> <ul style="list-style-type: none"> <li>■ Nut torn out</li> </ul>			
	<ul style="list-style-type: none"> <li>■ Or crack in adjusting nut</li> </ul>			
	<p><b>G- Hook</b></p> <ul style="list-style-type: none"> <li>■ Missing</li> </ul>		 088247	
	<ul style="list-style-type: none"> <li>■ Or function not available</li> </ul>		 088247	

# PERI Rental Criteria

## PEP Props



Prop	Description	Instruction	Billing Condition	Type
	<p>Crack in welding</p>			
	<p>Tube of the prop heated</p>			
	<p>Oil or grease at the thread</p>			

# PERI Rental Criteria

## PEP Props



Prop	Description	Instruction	Billing Condition	Type
------	-------------	-------------	-------------------	------

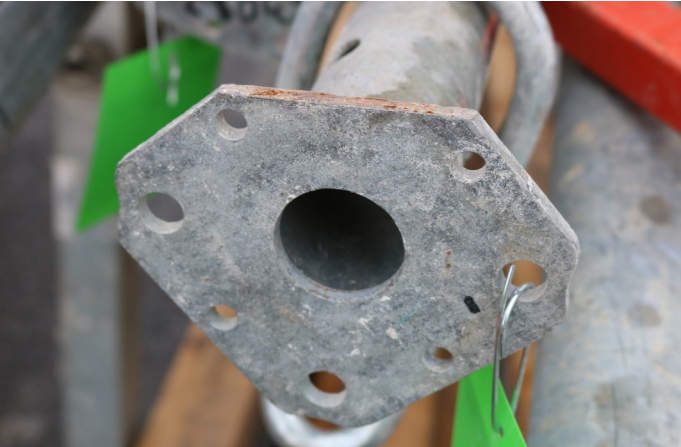















Head or Base Plate cut



# PERI Rental Criteria

## PEP Props



Tripod PEP Ergo (107152)	Description	Instruction	Billing Condition	Type
	<b>Legs bent</b>			
	<ul style="list-style-type: none"> <li>■ ≤ 10 mm</li> </ul>		 088244	
	<ul style="list-style-type: none"> <li>■ &gt; 10 mm</li> </ul>	 		
 <p>Nominal dimension 70mm</p>	<b>Bent spanner</b>			
	<ul style="list-style-type: none"> <li>■ ≤ 3 mm bent</li> </ul>			
	<ul style="list-style-type: none"> <li>■ &gt; 3 mm bent</li> </ul>		 088244	

# PERI Rental Criteria

## PEP Props



Universal tripod (028000)	No.	Name	Article number
---------------------------	-----	------	----------------

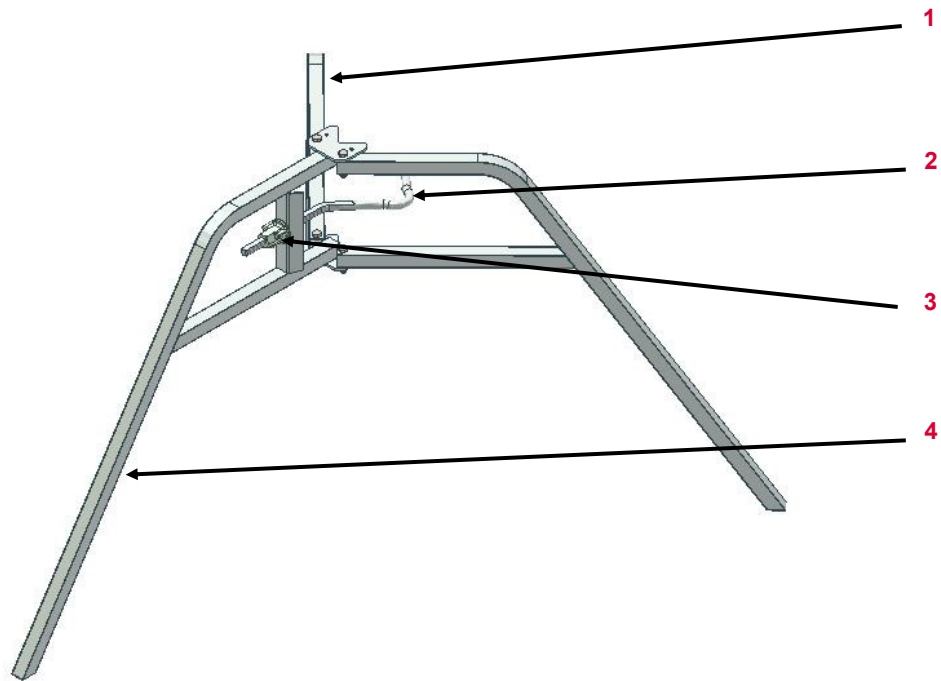

1	Pivoting arm	715643
2	Tension hoop	710161
3	Cam nut	030130
4	Support leg	715642

# PERI Rental Criteria

## PEP Props



Universal tripod	Description	Instruction	Billing Condition	Type
------------------	-------------	-------------	-------------------	------



**Pivoting Arm bent**

- If possible
  
- Or if not possible



WI\_20\_10\_PEP\_Extras\_TRIPOD\_14  
22\_en



088244



715643 (Pivoting Arm)



089149



**Support Leg bent**

- If possible
  
- Or if not possible



WI\_20\_10\_PEP\_Extras\_TRIPOD\_14  
22\_en



088244



# PERI Rental Criteria

## PEP Props



Universal tripod	Description	Instruction	Billing Condition	Type
------------------	-------------	-------------	-------------------	------



**Tension hoop bent**

- > 100°



WI\_20\_10\_PEP\_Extras\_TRIPOD\_Tensionhoop\_1427\_en



088920



**Nut at the cam nut torn**



030130 (cam nut)  
767043 (grooved pin)



088429



# PERI Rental Criteria

## PEP Props



Universal tripod	Description	Instruction	Billing Condition	Type
------------------	-------------	-------------	-------------------	------



**Crack in welding**

- Without damage of bordering parts
- Or with damages



**Crack in tension hoop**



# PERI Rental Criteria

## PEP Props



PEP Frame PRK	No.	Name	Article number
---------------	-----	------	----------------

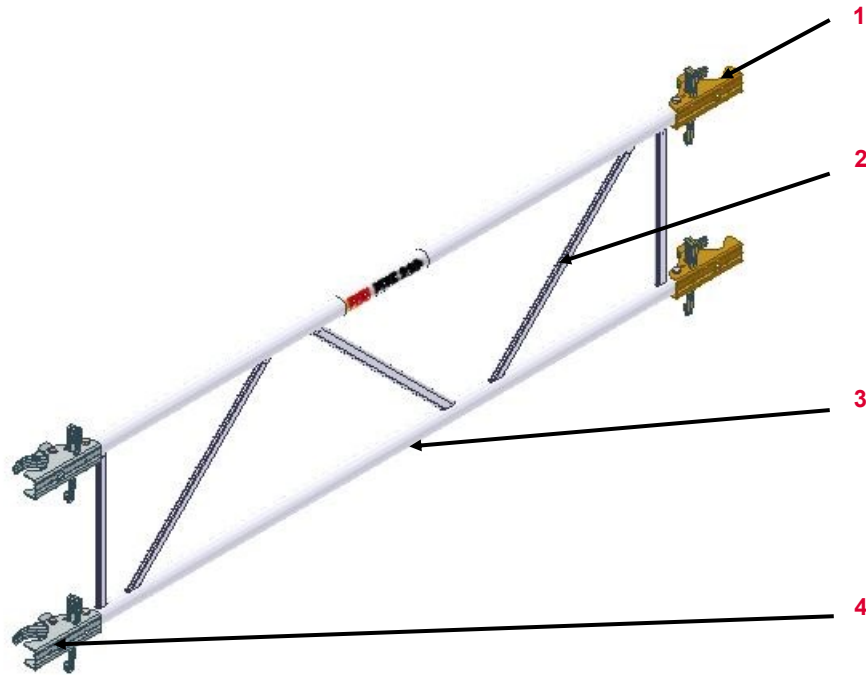







1	Connector PRK left	112210
2	Brace	
3	Frame	
4	Connector PRK right	112206

Valid for	Article number
Frame PRK 62,5	111811
Frame PRK 75	111812
Frame PRK 100	112813
Frame PRK 120	112814
Frame PRK 137,5	111815
Frame PRK 150	111814
Frame PRK 180	115980
Frame PRK 200	112718
Frame PRK 201,5	111815
Frame PRK 210	112788
Frame PRK 225	111816
Frame PRK 230	111817
Frame PRK 266	111818
Frame PRK 296	111819

# PERI Rental Criteria

## PEP Props



PEP Frame PRK	Description	Instruction	Billing Condition	Type																														
	<b>Bent frame</b>																																	
	<ul style="list-style-type: none"> <li>■ <math>\leq</math> permitted bent</li> <li>■ Or <math>&gt;</math> permitted bent</li> </ul>	<ul style="list-style-type: none"> <li></li> <li> </li> </ul>	<ul style="list-style-type: none"> <li></li> <li></li> </ul>	<ul style="list-style-type: none"> <li></li> <li></li> </ul>																														
	<table border="1"> <thead> <tr> <th>Article</th> <th>Perm. bent</th> </tr> </thead> <tbody> <tr><td>PRK 62,5</td><td>3,0 mm</td></tr> <tr><td>PRK 75</td><td>3,0 mm</td></tr> <tr><td>PRK 100</td><td>3,0 mm</td></tr> <tr><td>PRK 120</td><td>3,0 mm</td></tr> <tr><td>PRK 137,5</td><td>3,0 mm</td></tr> <tr><td>PRK 150</td><td>3,0 mm</td></tr> <tr><td>PRK 180</td><td>3,6 mm</td></tr> <tr><td>PRK 200</td><td>4,0 mm</td></tr> <tr><td>PRK 201,5</td><td>4,0 mm</td></tr> <tr><td>PRK 210</td><td>4,2 mm</td></tr> <tr><td>PRK 225</td><td>4,5 mm</td></tr> <tr><td>PRK 230</td><td>4,7 mm</td></tr> <tr><td>PRK 266</td><td>5,3 mm</td></tr> <tr><td>PRK 296</td><td>5,9 mm</td></tr> </tbody> </table>	Article	Perm. bent	PRK 62,5	3,0 mm	PRK 75	3,0 mm	PRK 100	3,0 mm	PRK 120	3,0 mm	PRK 137,5	3,0 mm	PRK 150	3,0 mm	PRK 180	3,6 mm	PRK 200	4,0 mm	PRK 201,5	4,0 mm	PRK 210	4,2 mm	PRK 225	4,5 mm	PRK 230	4,7 mm	PRK 266	5,3 mm	PRK 296	5,9 mm			
Article	Perm. bent																																	
PRK 62,5	3,0 mm																																	
PRK 75	3,0 mm																																	
PRK 100	3,0 mm																																	
PRK 120	3,0 mm																																	
PRK 137,5	3,0 mm																																	
PRK 150	3,0 mm																																	
PRK 180	3,6 mm																																	
PRK 200	4,0 mm																																	
PRK 201,5	4,0 mm																																	
PRK 210	4,2 mm																																	
PRK 225	4,5 mm																																	
PRK 230	4,7 mm																																	
PRK 266	5,3 mm																																	
PRK 296	5,9 mm																																	

# PERI Rental Criteria

## PEP Props



PEP Frame PRK	Description	Instruction	Billing Condition	Type
---------------	-------------	-------------	-------------------	------



**Connector left/ right  
useless/ deformed**



112210 (Connector left)  
112206 (Connector right)



088246



**Crack in welding at the brace**



# PERI Rental Criteria

## PEP Props



Feet MP 50 (027310)	Description	Instruction	Billing Condition	Type
---------------------	-------------	-------------	-------------------	------



**Dent in tube**

- ≤ 6 mm depth and ≤ Ø 60 mm
- Or > 6 mm depth
- Or > Ø 60 mm

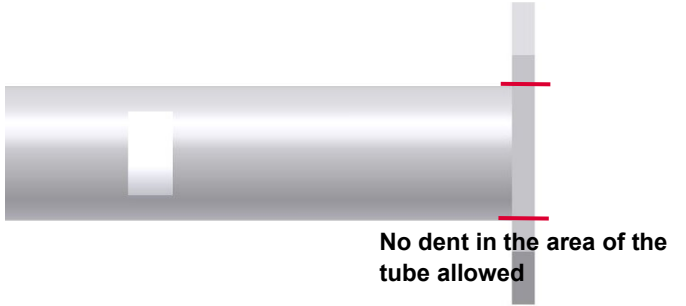

**Head or ground plate bent**

- ≤ 15 mm
- Or > 15 mm

















088244



# PERI Rental Criteria

## PEP Props



Feet MP 50 (027310)	Description	Instruction	Billing Condition	Type
	<p><b>Spring tube missing damaged</b></p> <ul style="list-style-type: none"> <li>■ Spring tube first version (black)</li> <li>■ Spring tube second version (orange)</li> </ul>	<p></p> <p></p>	<p></p> <p>088367</p> <p></p>	<p></p> <p></p>
	<p><b>Tension claw missing or damaged</b></p>	<p> 780108 (spring tube) 780105 (tension claw) 710381 (nut) 780702 (washer 2x)</p>	<p> 088367 088368 088369</p>	<p></p>
	<p><b>Tension claw not tightened</b></p> <ul style="list-style-type: none"> <li>■ Tension claw should have some resistance when moved by hand</li> </ul>	<p></p>	<p></p>	<p></p>

# PERI Rental Criteria

## PEP Props



Crosshead 20/24 (027890)	Description	Instruction	Billing Condition	Type
--------------------------	-------------	-------------	-------------------	------

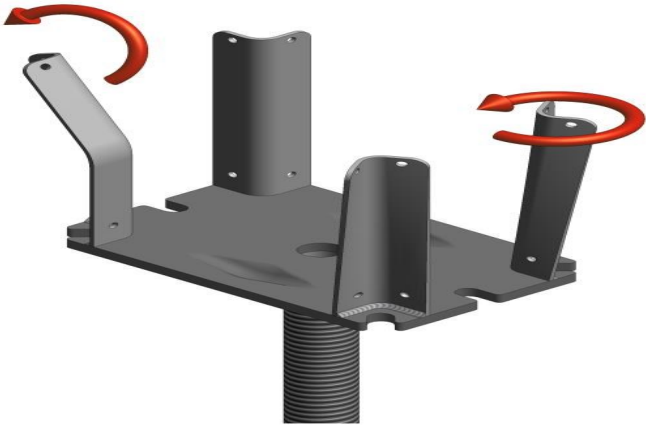

**Plaid**

- Bent (without damaged welding)
- Or bent (with damaged welding)
- Or missing

	WI_20_10_PEP_Extras_Crosshead_Plaid_1422_en		088395	
	WI_20_10_PEP_Extras_Crosshead_Plaid_welding_1422_en		088394	
	WI_20_10_PEP_Extras_Crosshead_Plaid_welding_1422_en		088394	



**Base plate**

- > 5 mm

--	--	--	--	--

# PERI Rental Criteria

## PEP Props



Crosshead 20/24   S (027890   028680)	Description	Instruction	Billing Condition	Type
---------------------------------------	-------------	-------------	-------------------	------













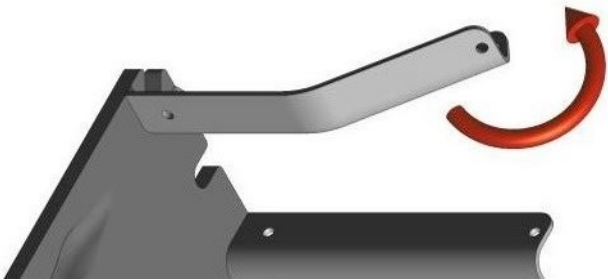







Handle welded (No standard welding)



# PERI Rental Criteria

## PEP Props



Crosshead 20/24S (028680)	Description	Instruction	Billing Condition	Type
	<p><b>Plaid</b></p> <ul style="list-style-type: none"> <li>■ Bent (without crack in welding)</li> <li>■ Or bent (with crack in welding)</li> <li>■ Or missing</li> </ul>	<ul style="list-style-type: none"> <li> WI_20_10_PEP_Extras_Crosshead_Plaid_1422_en</li> <li> WI_20_10_PEP_Extras_Crosshead_Plaid_welding_1422_en</li> </ul>	<ul style="list-style-type: none"> <li> 088395</li> <li> 088394</li> <li> 088394</li> </ul>	<ul style="list-style-type: none"> <li></li> <li></li> <li></li> </ul>
	<p><b>Bent base plate</b></p> <ul style="list-style-type: none"> <li>■ &gt; 5 mm</li> </ul>	<ul style="list-style-type: none"> <li> </li> </ul>	<ul style="list-style-type: none"> <li></li> </ul>	<ul style="list-style-type: none"> <li></li> </ul>
	<p><b>Safety hatch</b></p>	<ul style="list-style-type: none"> <li> WI_20_10_PEP_Extras_Crosshead_Safetybracket_1434_en</li> </ul>	<ul style="list-style-type: none"> <li> 088898</li> </ul>	<ul style="list-style-type: none"> <li></li> </ul>

# PERI Rental Criteria

## PEP Props



Brace clamp (027940; 027790)	No.	Name	Article number
------------------------------	-----	------	----------------

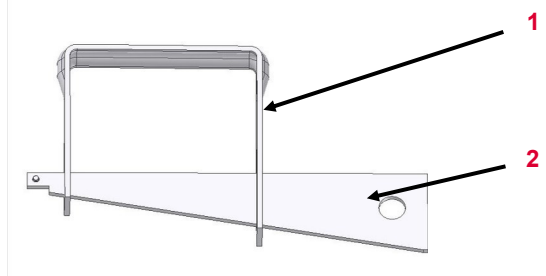

- 1 Bracket
- 2 Wedge

Damage	Description	Instruction	Billing Condition	Type
--------	-------------	-------------	-------------------	------

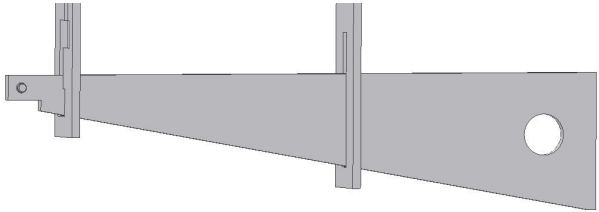

Wedge missing

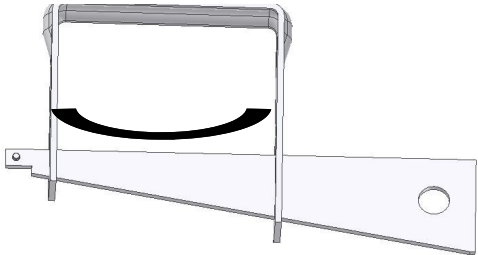

Bracket bent



















088244



# PERI Rental Criteria

## Glossary Icons



Icon	Bedeutung	Icon	Bedeutung	Icon	Bedeutung
	Not Ok– material is scrap		Billing necessary (customer)		Optical damage
	OK– material stays in rental park		No Billing necessary		Functional damage
	Scrap material– it's not permitted to hand out the material because of safety aspects		Shorten the material		Functional damage– it's <b>not</b> permitted to hand out the material
	Repair according to instruction		Mark the material		Static damage– it's <b>not</b> permitted to hand out the material
	Fix part cold– Afterwards check the weld seam and bordering components		Replace damaged material		
	Repair after local economic efficiency calculation		Replace missing material		
	Clean the material				