

PERI Rental Criteria

Safety Systems



Contact

PERI GmbH
Formwork Scaffolding
Engineering
P.O. Box 1264
89264 Weissenhorn, Germany
Phone +49 (0) 7309.950-0
Fax +49 (0) 7309.951-0
rental-criteria@peri.de

Content	Page	Changes made	Date Initial	Page
Side Mesh Barrier PMB	2	New Version	10/2016 fw	
Fold Mesh	4	Hammock Parts added	02/2021 fw	9
Post PP Post Increase PPE	5	Hammock Connector and Adapter added	09/2021 fw	12+13
Slab Foot Side Foot	6	Prokit Alpha added	04/2022 fw	2
Uni Clamp PUC	7	Prokit S parts added	12/2023 fw	14
Sheet Piing Clamp	8			
Hammock System	9			
Prokit S	14			

PERI Rental Criteria

Safety Systems



Side Mesh Barrier PMB	No.	Name	Article number
-----------------------	-----	------	----------------

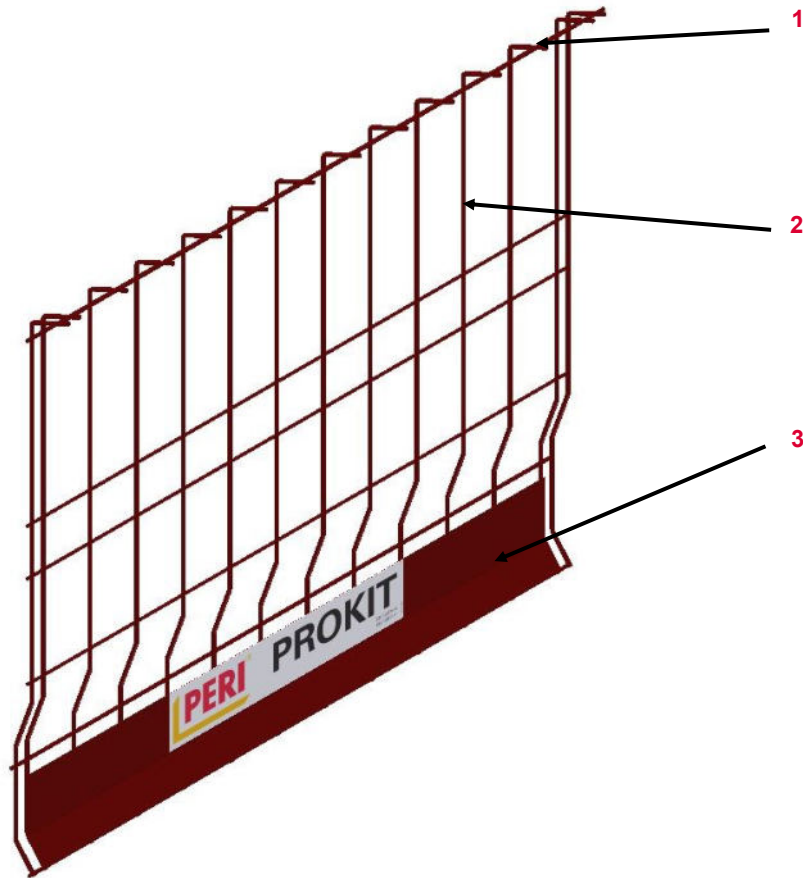



















- 1 Horizontal bar
- 2 Vertical bar
- 3 Base plate

Valid for	Article number
Side Mesh Barrier PMB 240	126371
Side Mesh Barrier PMB 120	126376
Side Mesh Barrier PMB 90	126381
Side Mesh Barrier PMB 130	117327
Side Mesh Barrier PMB 260	117236
Barrier ALPHA T 90	033605
Barrier ALPHA T120	033604
Barrier ALPHA T 240	033603
Barrier ALPHA T 260	033602
Side Mesh Barrier PMB S 260	138084
Side Mesh Barrier PMB S 240	138085
Side Mesh Barrier PMB S 120	138086
Side Mesh Barrier PMB S 90	138087
Make-up Barrier PMB S 260	033705

PERI Rental Criteria

Safety Systems











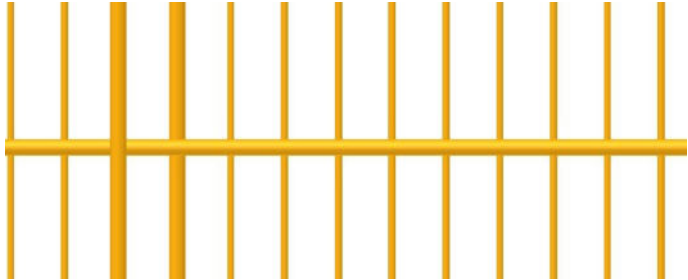



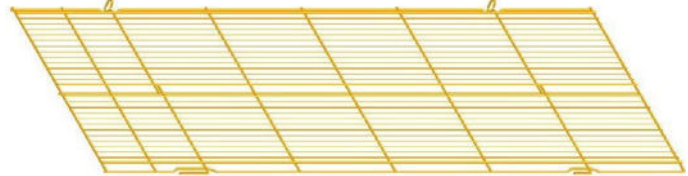

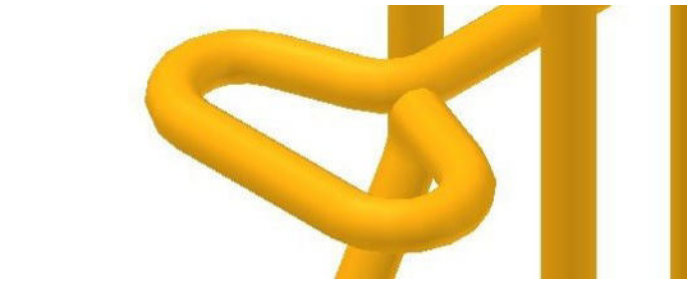

Side Mesh Barrier PMB	Description	Instruction	Billing Condition	Type
	<p>Bar broken</p>			
	<p>Mesh</p> <ul style="list-style-type: none"> ■ Bent > 15 mm 			
	<ul style="list-style-type: none"> ■ Or kink 			
	<p>Base plate bent</p> <ul style="list-style-type: none"> ■ If possible 			
	<ul style="list-style-type: none"> ■ Or if not possible 			

PERI Rental Criteria

Safety Systems











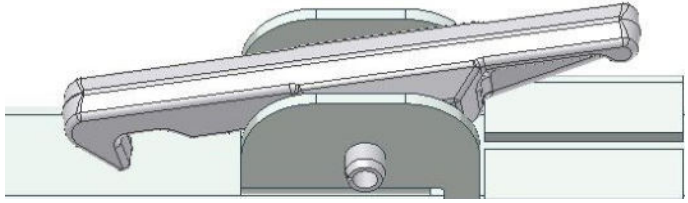













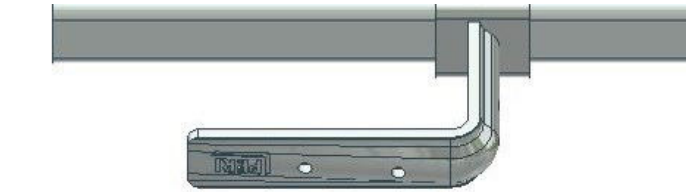

Fold Mesh (118350)	Description	Instruction	Billing Condition	Type
	<p>Bar broken</p>			
	<p>Bent</p> <ul style="list-style-type: none"> ■ < 20 cm ■ Or > 20 cm 	<ul style="list-style-type: none">   	<ul style="list-style-type: none">   	<ul style="list-style-type: none">  
	<p>Hook eyelet bent</p> <ul style="list-style-type: none"> ■ If possible ■ Or if not possible 	<ul style="list-style-type: none">   	<ul style="list-style-type: none">   	<ul style="list-style-type: none">  

PERI Rental Criteria

Safety Systems



Post (117325) Post Increase (118296)	Description	Instruction	Billing Condition	Type
	<p>Safety hook</p> <ul style="list-style-type: none"> ■ Missing ■ Or damaged by force 	<ul style="list-style-type: none">  710418 (Safety hook) 724567 (Dowel pin)  710418 (Safety hook) 724567 (Dowel pin) 	<ul style="list-style-type: none">   	<ul style="list-style-type: none">  
	<p>Dents in Profile</p> <ul style="list-style-type: none"> ■ Edges not affected ■ Or edges affected 	<ul style="list-style-type: none">    	<ul style="list-style-type: none">   	<ul style="list-style-type: none">  
	<p>Slider</p> <ul style="list-style-type: none"> ■ Missing ■ Or damaged by force 	<ul style="list-style-type: none">  115673 (Slider)  115673 (Slider) 	<ul style="list-style-type: none">   	<ul style="list-style-type: none">  
	<p>L piece bent missing</p>	<ul style="list-style-type: none">  	<ul style="list-style-type: none">  	<ul style="list-style-type: none"> 

PERI Rental Criteria

Safety Systems



Slab Foot Side Foot (117323; 117324;033609	Description	Instruction	Billing Condition	Type
--	-------------	-------------	-------------------	------

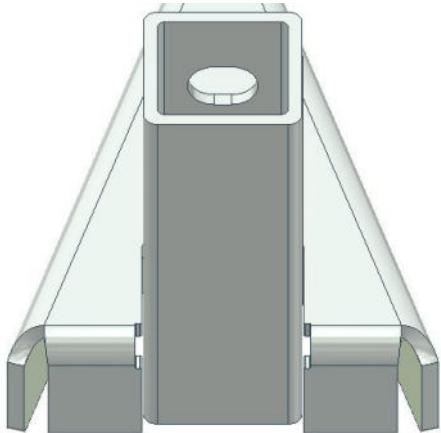

Connection bent

- Post can be inserted



- Or post can't be inserted

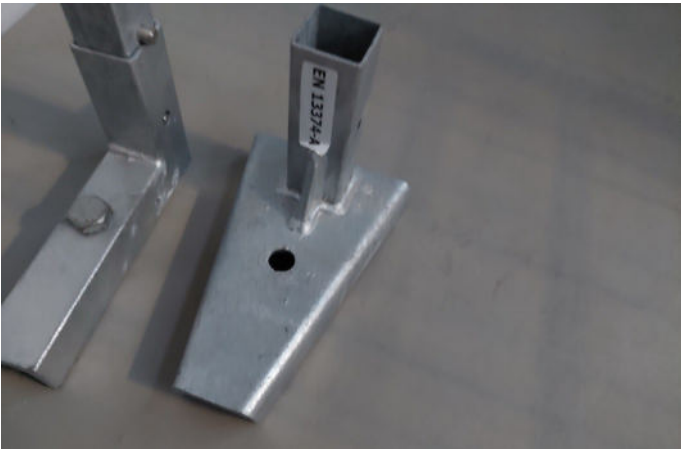

Base bent

- If possible













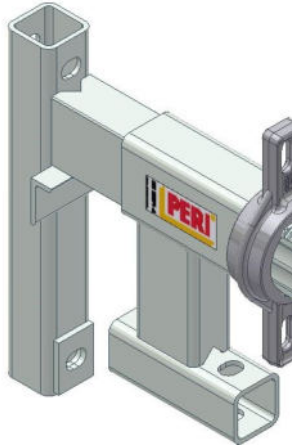



- Or if not possible



PERI Rental Criteria

Safety Systems











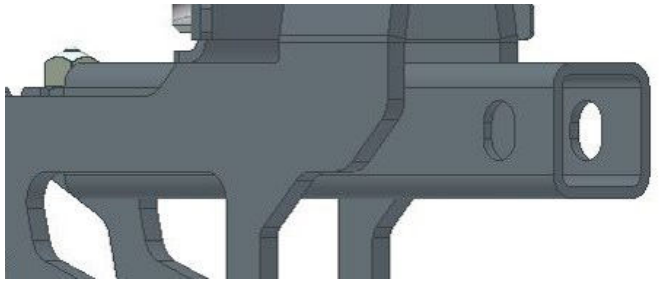





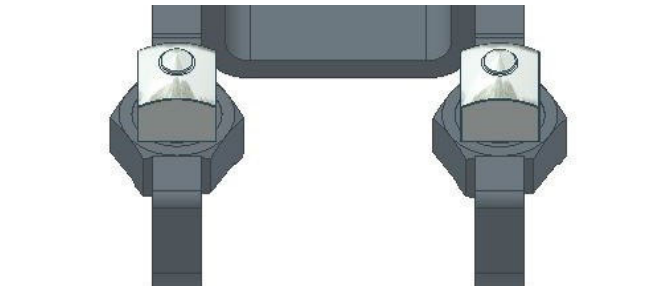

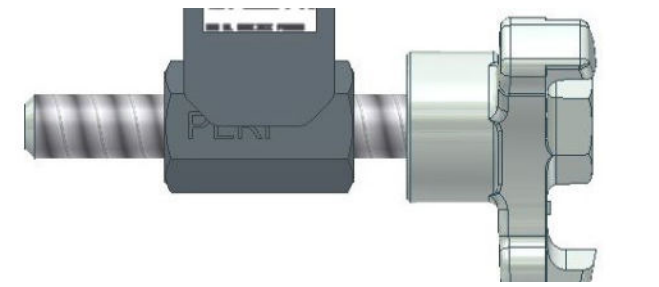

Uni Clamp PUC (118660)	Description	Instruction	Billing Condition	Type
	<p>Connection bent</p> <ul style="list-style-type: none"> ■ Post can be inserted ■ Or post can't be inserted 	<ul style="list-style-type: none">    	<ul style="list-style-type: none">   	<ul style="list-style-type: none">  
	<p>Impact nut</p> <ul style="list-style-type: none"> ■ Missing ■ Or damaged by force 	<ul style="list-style-type: none">  065048 (Impact nut)  065048 (Impact nut) 	<ul style="list-style-type: none">   	<ul style="list-style-type: none">  

PERI Rental Criteria

Safety Systems



Sheet Piling Clamp PSC (126330)	Description	Instruction	Billing Condition	Type	
	Connection bent				
	<ul style="list-style-type: none"> ■ Post can be inserted 				
	<ul style="list-style-type: none"> ■ Or post can't be inserted 				
	Studs				
	<ul style="list-style-type: none"> ■ Missing 		112662 (Stud)		
	<ul style="list-style-type: none"> ■ Or damaged by force 		112662 (Stud)		
	Clamp bolt				
	<ul style="list-style-type: none"> ■ Missing 		126337 (Clamp bolt)		
	<ul style="list-style-type: none"> ■ Or damaged by force 		126337 (Clamp bolt)		

PERI Rental Criteria

Safety Systems



HAMMOCK Extension Tube (136853 137174 136858)	Description	Instruction	Billing Condition	Type
---	-------------	-------------	-------------------	------

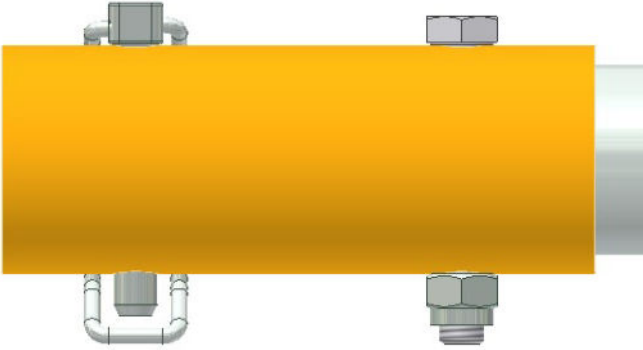

Pipe Plug | Bolt | Nut

- Missing
- Or damaged due to force



136852 (Pipe Plug)
725142 (Bolt M8x55)
711071 (Nut)



136852 (Pipe Plug)
725142 (Bolt M8x55)
711071 (Nut)



Tube Bent



PERI Rental Criteria

Safety Systems



HAMMOCK Connection –T (136845)	Description	Instruction	Billing Condition	Type
--------------------------------	-------------	-------------	-------------------	------

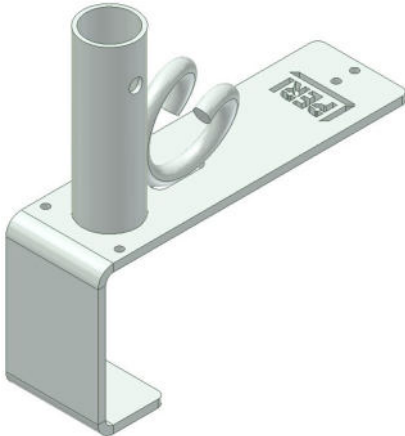

Parts bent

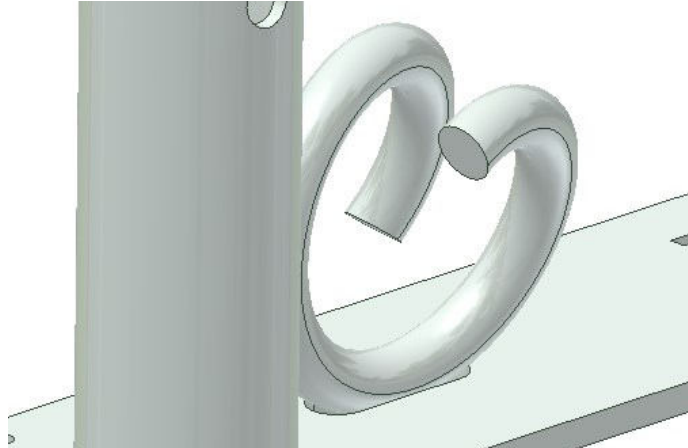

Sharp edges at the spring

■ If possible



Remove sharp areas with a file















■ Or if not possible



PERI Rental Criteria

Safety Systems















HAMMOCK Connection S (137463)	Description	Instruction	Billing Condition	Type
	<p>Pipe Plug</p> <ul style="list-style-type: none"> ■ Missing ■ Or damaged due to force 	<ul style="list-style-type: none">  136852 (Pipe Plug)  136852 (Pipe Plug) 	<ul style="list-style-type: none">   	<ul style="list-style-type: none">  
	<p>Spring bent</p>	 		

PERI Rental Criteria

Safety Systems









HAMMOCK Connection S (137463)	Description	Instruction	Billing Condition	Type
	<p>Dowel pin</p> <ul style="list-style-type: none"> ■ Missing ■ Or damaged due to force 	<p>  136852 (Dowel Pin) </p> <p>  136852 (Dowel Pin) </p>	<p>  </p> <p>  </p>	<p>  </p> <p>  </p>
	<p>Marking not readable</p>	<p>   </p>	<p>  </p>	<p>  </p>

PERI Rental Criteria

Safety Systems



HAMMOCK Universal Adapter S (137457)	Description	Instruction	Billing Condition	Type
	<p>Parts bent</p> <ul style="list-style-type: none"> ■ If possible ■ Or if not possible 	<p>If possible: </p> <p>Or if not possible: </p>	<p>If possible: </p> <p>Or if not possible: </p>	<p>If possible: </p> <p>Or if not possible: </p>

PERI Rental Criteria

Safety Systems



Alpha Post (033607 033707 033706 033708)	Description	Instruction	Billing Condition	Type
--	-------------	-------------	-------------------	------



Bracket bent

- If possible
- Or if not possible



Nut missing



PERI Rental Criteria

Safety Systems



Alpha Post (033607 033707 033706 033708)	Description	Instruction	Billing Condition	Type
--	-------------	-------------	-------------------	------

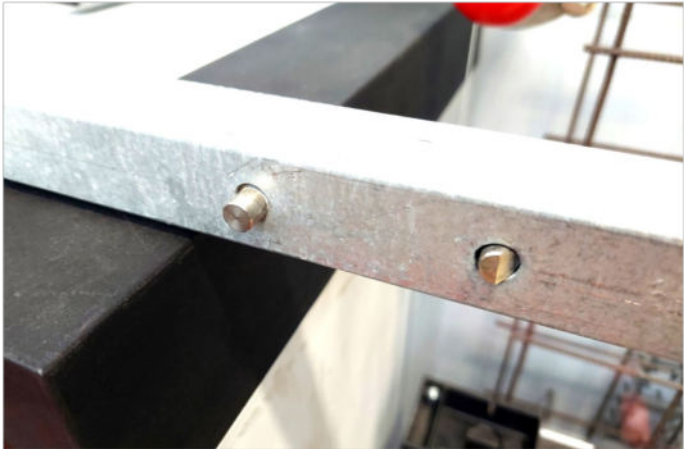

Locking mechanism damaged

- If possible
- Or if not possible









Plastic cap missing



PERI Rental Criteria

Safety Systems



Alpha Foot Eco Alpha Foot Eco Double	Description	Instruction	Billing Condition	Type
<p>(033610 033749)</p> 	<p>Tube or plaid bent</p> <ul style="list-style-type: none"> ■ If possible ■ Or if not possible 	<ul style="list-style-type: none">   	<ul style="list-style-type: none">   	<ul style="list-style-type: none">  

PERI Rental Criteria

Safety Systems



Alpha Edge Fastener (033611)	Description	Instruction	Billing Condition	Type
------------------------------	-------------	-------------	-------------------	------



Tube or plaid bent











- If possible
- Or if not possible



PERI Rental Criteria

Safety Systems











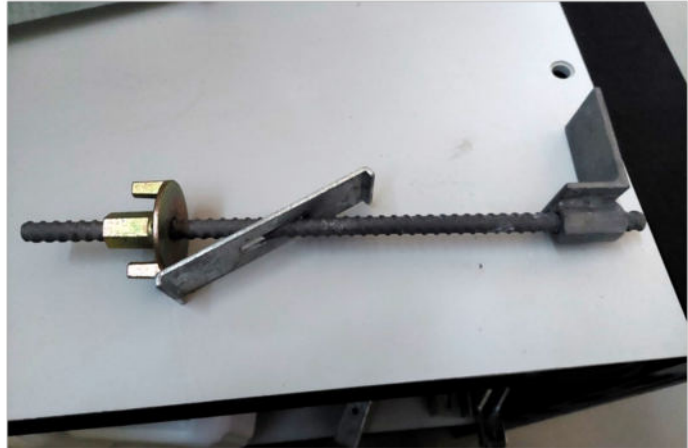

Alpha Slider (033608)	Description	Instruction	Billing Condition	Type
	<p>Bracket bent</p> <ul style="list-style-type: none"> ■ If possible ■ Or if not possible 	<ul style="list-style-type: none">   	<ul style="list-style-type: none">   	<ul style="list-style-type: none">  
	<p>Nut missing</p>	<ul style="list-style-type: none">  	<ul style="list-style-type: none">  	<ul style="list-style-type: none"> 

PERI Rental Criteria

Safety Systems













Alpha Shaft-lock (033612)	Description	Instruction	Billing Condition	Type
	<p>Rod bent</p>			
	<p>Sliding plate</p> <ul style="list-style-type: none"> ■ Missing ■ Or bent 	<ul style="list-style-type: none">   	<ul style="list-style-type: none">   	<ul style="list-style-type: none">  

PERI Rental Criteria

Safety Systems













Alpha Shaft-lock (033612)	Description	Instruction	Billing Condition	Type
	<p>Cam nut</p> <ul style="list-style-type: none"> ■ Missing ■ Or damaged du to force 	<p>   </p>	<p>   </p>	<p>   </p>
	<p>Angled plate damaged</p>	<p>  </p>	<p>  </p>	<p>  </p>

PERI Rental Criteria

Safety Systems



Alpha Steelweb (033613)	Description	Instruction	Billing Condition	Type
	<p>Parts bent</p> <ul style="list-style-type: none"> ■ If possible ■ Or if not possible 	<p>If possible: </p> <p>Or if not possible: </p>	<p>If possible: </p> <p>Or if not possible: </p>	<p></p> <p></p>
	<p>Nut missing</p>	<p></p>	<p></p>	<p></p>

PERI Rental Criteria

Safety Systems



ALPHA Clamp 600 (033614 033751)	Description	Instruction	Billing Condition	Type
-----------------------------------	-------------	-------------	-------------------	------



Nut missing



Rod bended



PERI Rental Criteria

Safety Systems



ALPHA Clamp 600 (033614 033751)	Description	Instruction	Billing Condition	Type
-----------------------------------	-------------	-------------	-------------------	------

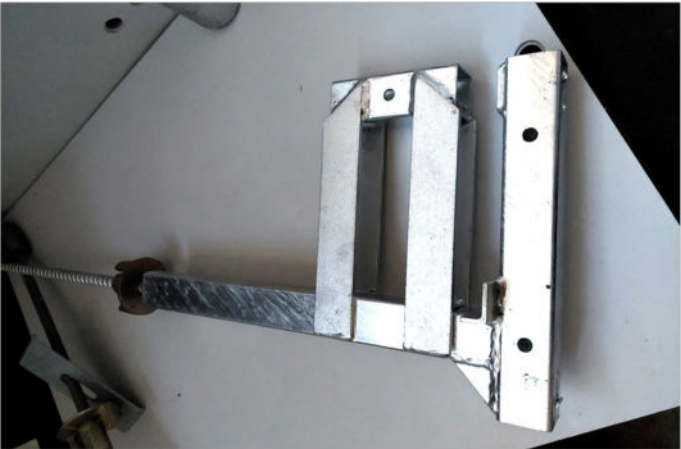

Parts bent







- If possible
- Or if not possible



PERI Rental Criteria

Safety Systems











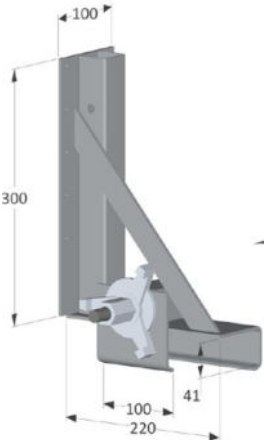

Alpha Balcony Fastener (033615)	Description	Instruction	Billing Condition	Type
	<p>Parts bent</p> <ul style="list-style-type: none"> ■ If possible ■ Or if not possible 	<ul style="list-style-type: none">   	<ul style="list-style-type: none">   	<ul style="list-style-type: none">  

PERI Rental Criteria

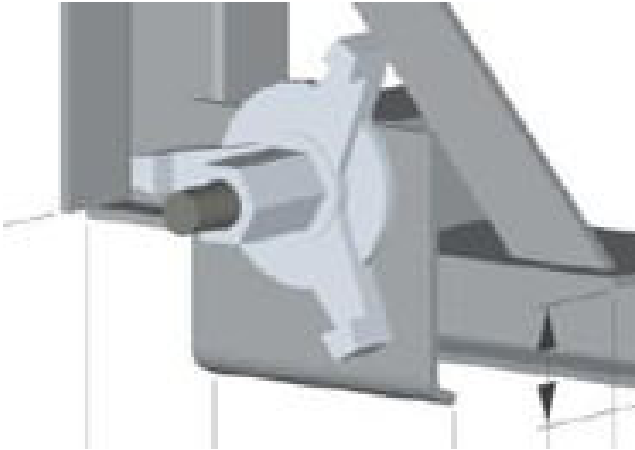
Safety Systems



Alpha VT20 Clamp (033616)	Description	Instruction	Billing Condition	Type
	<p>Parts bent</p> <ul style="list-style-type: none"> ■ If possible ■ Or if not possible 	<p>   </p>	<p>   </p>	<p>   </p>
	<p>Wingnut missing</p>	<p></p>	<p></p>	<p></p>

PERI Rental Criteria

Safety Systems



Alpha Sheet Pile Clamp (033617)	Description	Instruction	Billing Condition	Type
---------------------------------	-------------	-------------	-------------------	------



Clamp missing

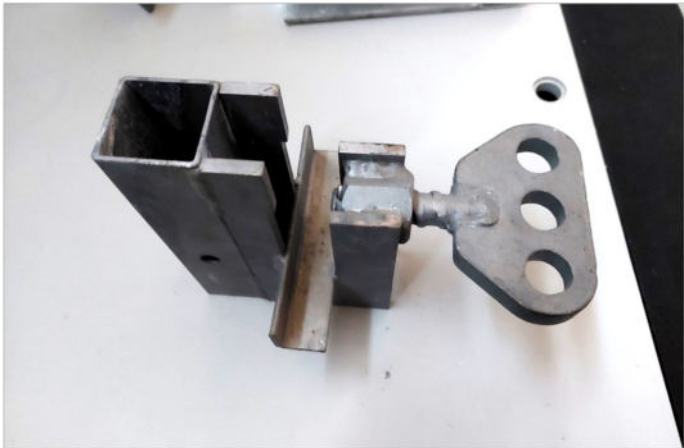

Parts bent

- If possible









- Or if not possible



PERI Rental Criteria

Safety Systems



















Alpha Stair Bracket (033618)	Description	Instruction	Billing Condition	Type
	<p>Parts bent</p> <ul style="list-style-type: none"> ■ If possible ■ Or if not possible 	<ul style="list-style-type: none">   	<ul style="list-style-type: none">   	<ul style="list-style-type: none">  

PERI Rental Criteria

Glossary Icons



Icon	Significance	Icon	Significance	Icon	Significance
	Not Ok– material is scrap		Billing necessary (customer)		Optical damage
	OK– material stays in rental park		No Billing necessary		Functional damage
	Scrap material– it's not permitted to hand out the material because of safety aspects		Shorten the material		Functional damage— it's not permitted to hand out the material
	Repair according to instruction		Mark the material		Static damage— it's not permitted to hand out the material
	Fix material cold– Afterwards check weld seams and bordering components		Replace damaged material		
	Repair after local economic efficiency calculation		Replace missing material		
	Clean the material				