

# PERI Rental Criteria

## VTC Tunnel Formwork Carriage



### Contact

**PERI GmbH**  
**Formwork Scaffolding**  
**Engineering**  
 P.O. Box 1264  
 89264 Weissenhorn, Germany  
 Phone +49 (0) 7309.950-0  
 Fax +49 (0) 7309.951-0  
 rental-criteria@peri.de

Content	Page
Wheel Block	2
Hydraulic Drive	5
Valve Block	8
Longitudinal Beam	11
Liftframe LALD	13
Hingeslide LALD	15
Telescopic Prop	18
Accessories	20
Glossary	37

Changes made	Date   Initial	Page
New Version	04/2019   fw	

# PERI Rental Criteria

## VTC Tunnel Formwork Carriage



### Wheel Block VARIOKIT 300 KN (133664)

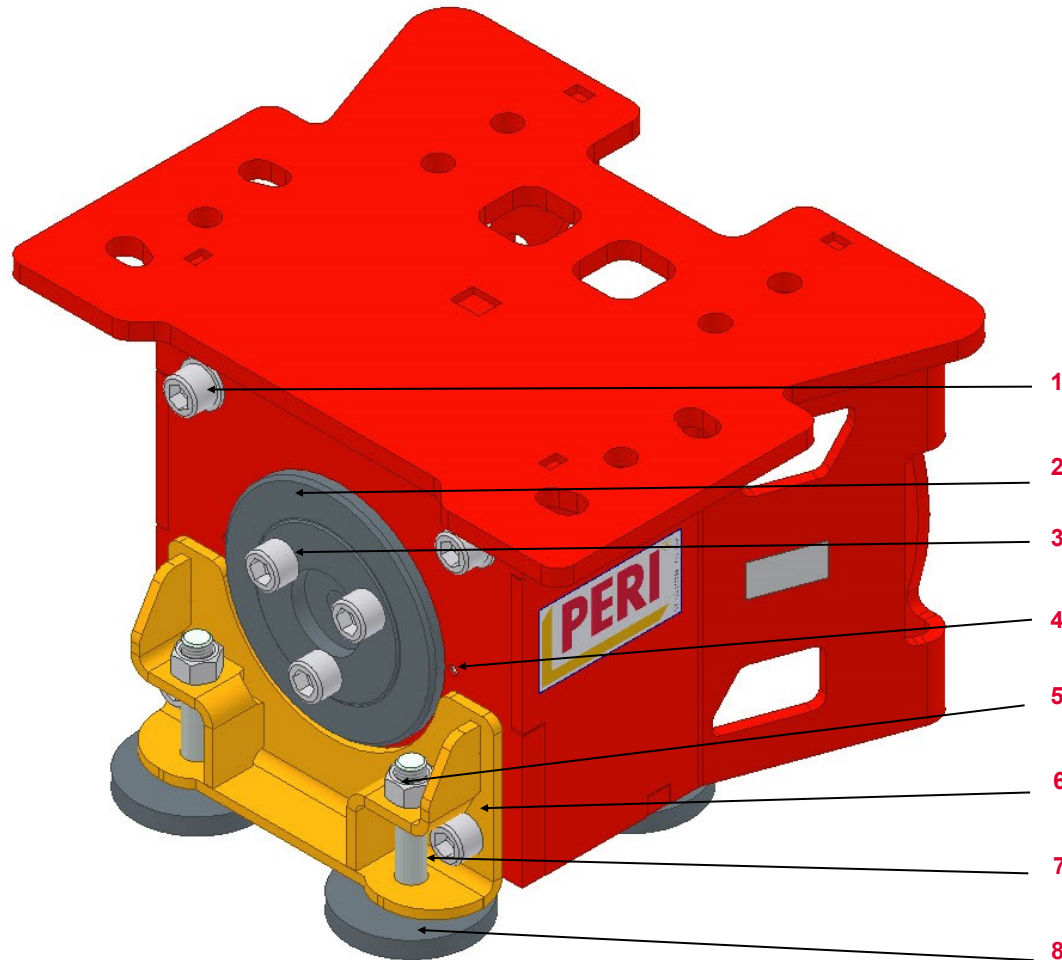















No.	Name	Article number
1	Bolt M20x180	131738
2	Wheel D300	133654
3	Bolt M20x200 10.9	133475
4	Sleeve	780807
5	Nut M 20	133475
6	Roll Guide	133648
7	Fitting Bolt M20 x 120	133663
8	Roll	133643

# PERI Rental Criteria

## VTC Tunnel Formwork Carriage



Wheel Block VARIOKIT 300 KN (133664)	Description	Instruction	Billing	Type
	<b>Wheel</b> <ul style="list-style-type: none"> <li>■ Missing</li> </ul>			
	<ul style="list-style-type: none"> <li>■ Or damaged due to force</li> </ul>			
	<ul style="list-style-type: none"> <li>■ Or wheel is difficult to move</li> </ul>	 <p>Open the block and grease the taper roller bearings</p>		
	<b>Bolts   Nuts   Pins missing</b>			

# PERI Rental Criteria

## VTC Tunnel Formwork Carriage



Wheel Block VARIOKIT 300 KN (133664)	Description	Instruction	Billing	Type
--------------------------------------	-------------	-------------	---------	------



**Roll**

- Missing
- Or damaged due to force
- Or worn



**Roll guide**

- Missing
- Or damaged due to force



# PERI Rental Criteria

## VTC Tunnel Formwork Carriage



### Hydraulic Drive VARIOKIT (133953)

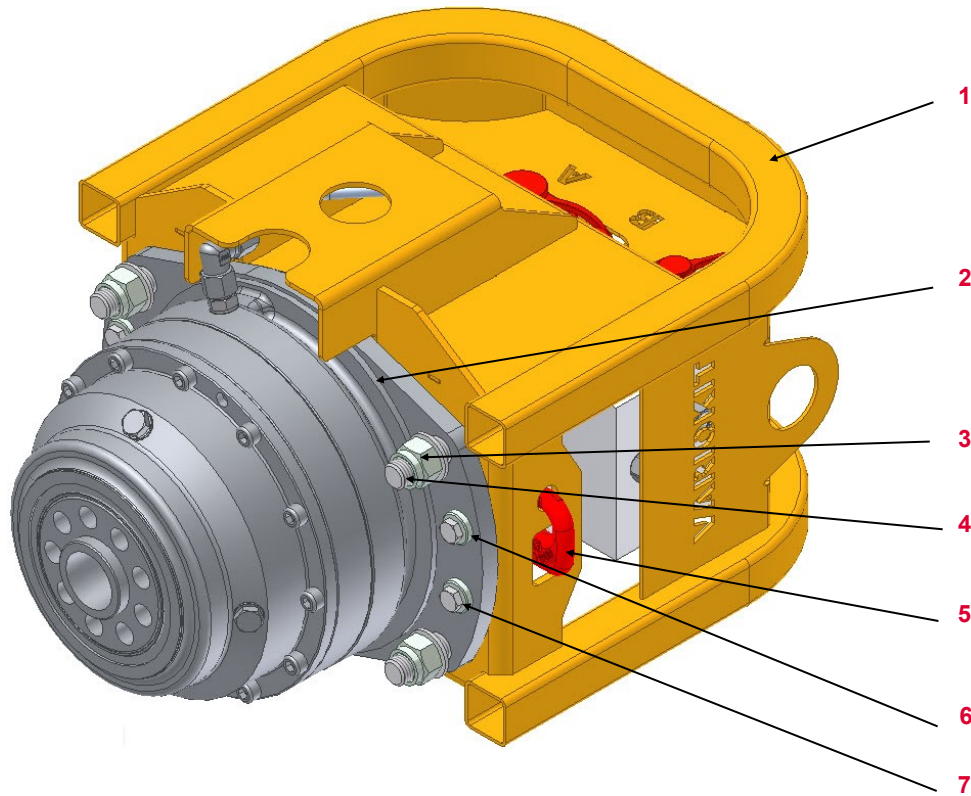









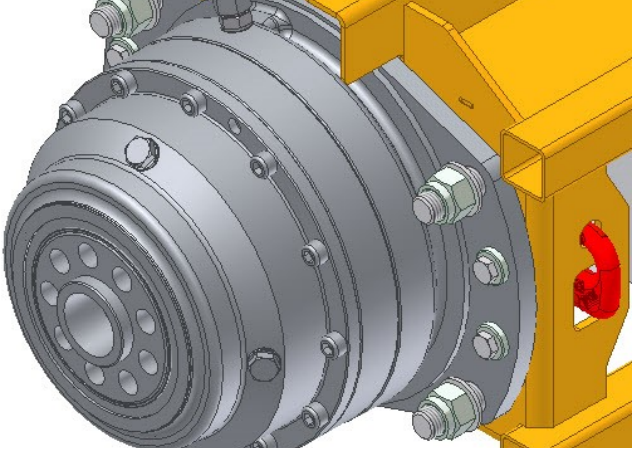





No.	Name	Article number
1	Case	133951
2	Drive	133952
3	Nut M20	781053
4	Bolt M20x70	721912
5	RFID Tag	129441
6	Sleeve	133943
7	Bolt M10x45	104692

# PERI Rental Criteria

## VTC Tunnel Formwork Carriage













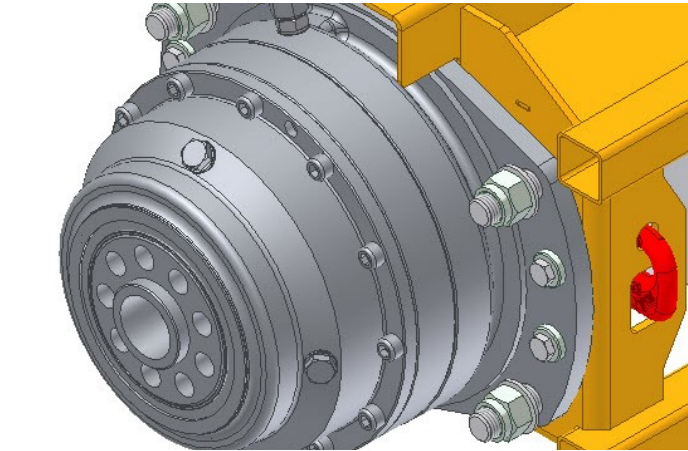

Hydraulic Drive VARIOKIT (133953)	Description	Instruction	Billing	Type
	<p><b>Function of Drive not given</b></p> <ul style="list-style-type: none"> <li>■ If repair possible</li> <li>■ Or if not possible</li> </ul>	<ul style="list-style-type: none"> <li></li> <li></li> </ul>	<ul style="list-style-type: none"> <li></li> <li></li> </ul>	<ul style="list-style-type: none"> <li></li> <li></li> </ul>
	<p><b>Plates bent</b></p> <ul style="list-style-type: none"> <li>■ If repair possible</li> <li>■ Or if not possible</li> </ul>	<ul style="list-style-type: none"> <li></li> <li></li> </ul>	<ul style="list-style-type: none"> <li></li> <li></li> </ul>	<ul style="list-style-type: none"> <li></li> <li></li> </ul>

# PERI Rental Criteria

## VTC Tunnel Formwork Carriage



Hydraulic Drive VARIOKIT (133953)	Description	Instruction	Billing	Type
	<b>Case bent</b>			
	<ul style="list-style-type: none"> <li>■ If possible</li> </ul>			
	<ul style="list-style-type: none"> <li>■ Or if not possible</li> </ul>			
	<b>Bolts   Sleeve   RFID Tag</b>			
	<ul style="list-style-type: none"> <li>■ Missing</li> </ul>			
	<ul style="list-style-type: none"> <li>■ Or damaged due to force</li> </ul>			

# PERI Rental Criteria

## VTC Tunnel Formwork Carriage



### Valve Block Hydraulic Drive (134002)

No. Name Article number

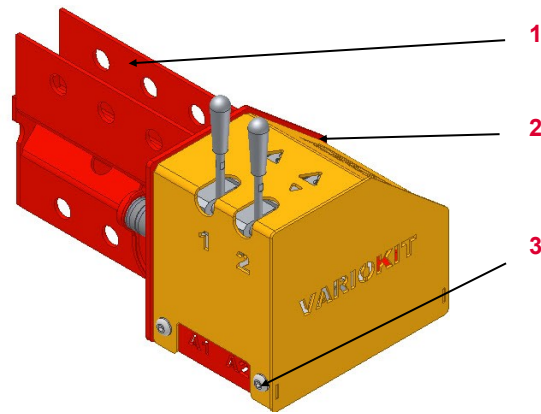

1 Connector 133954

2 Case 133995

3 Bolt M10x25 125991

4 RFID Tag 129441

5 Valve Block 133954

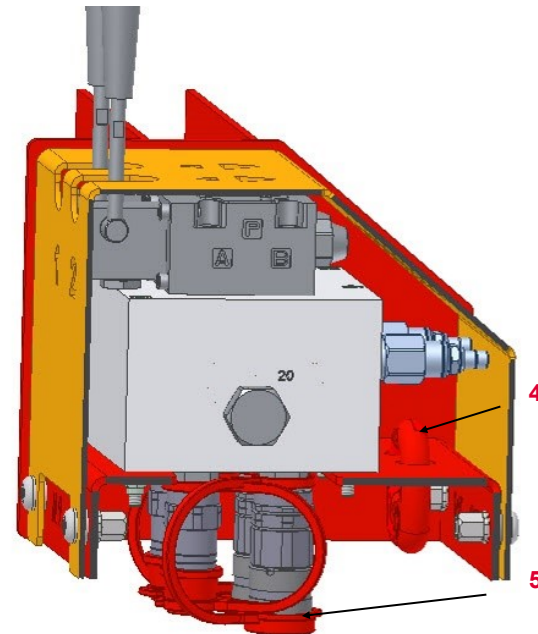

# PERI Rental Criteria

## VTC Tunnel Formwork Carriage



Valve Block Hydraulic Drive (134002)	Description	Instruction	Billing	Type
--------------------------------------	-------------	-------------	---------	------

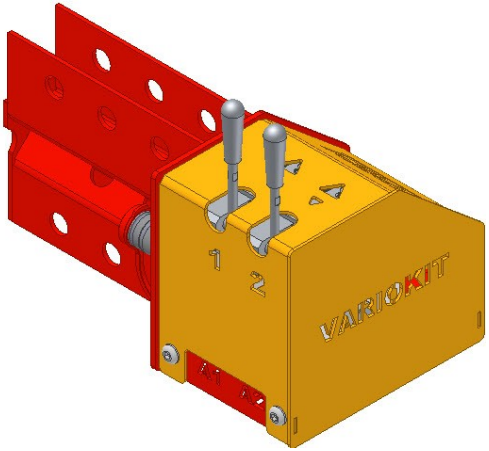

Connector | Case damaged

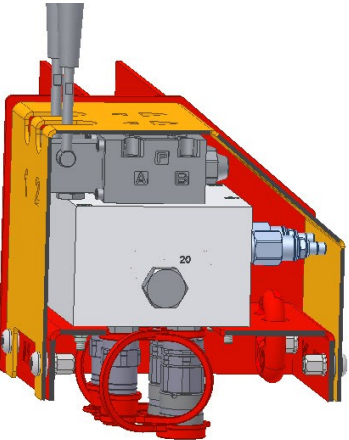

Function not given

- If possible







- Or if not possible

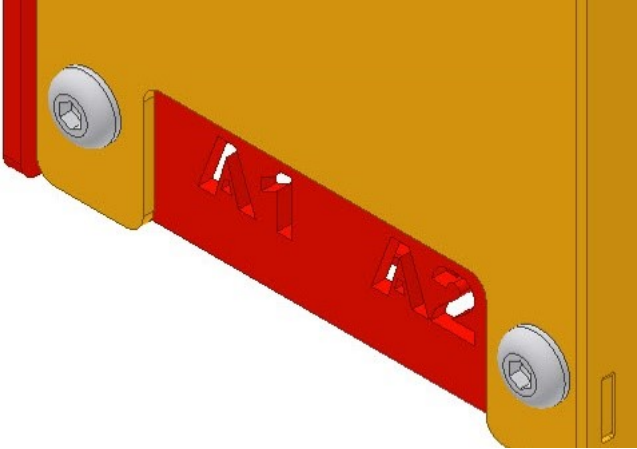

# PERI Rental Criteria

## VTC Tunnel Formwork Carriage



Valve Block Hydraulic Drive (134002)	Description	Instruction	Billing	Type
	Bolts missing			

# PERI Rental Criteria

## VTC Tunnel Formwork Carriage



Longitudinal Beam VARIOKIT	No.	Name	Article number
----------------------------	-----	------	----------------

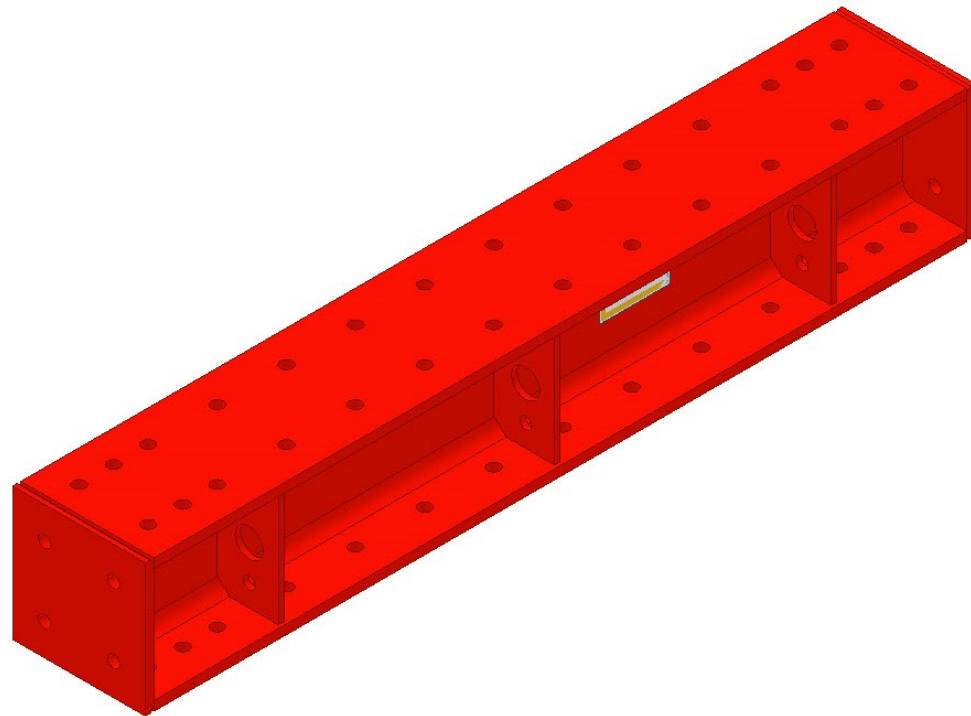









Valid for	Article number
Longitudinal Beam VARIOKIT 150	129895
Longitudinal Beam VARIOKIT 250	129898
Longitudinal Beam VARIOKIT 300	129901
Longitudinal Beam VARIOKIT 350	129904
Longitudinal Beam VARIOKIT 500	129907
Longitudinal Beam VARIOKIT 750	129910
Longitudinal Beam VARIOKIT 1000	129913

# PERI Rental Criteria

## VTC Tunnel Formwork Carriage



Longitudinal Beam VARIOKIT	Description	Instruction	Billing	Type																
	<b>Beam bent</b>																			
	■ ≤ perm. bent (l/500)																			
	■ Or > perm. bent	 																		
	<table border="1"> <thead> <tr> <th data-bbox="875 820 1077 858">Length</th> <th data-bbox="1084 820 1294 858">Perm.bent</th> </tr> </thead> <tbody> <tr> <td data-bbox="875 868 1077 890">150</td> <td data-bbox="1084 868 1294 890">3 mm</td> </tr> <tr> <td data-bbox="875 900 1077 922">250</td> <td data-bbox="1084 900 1294 922">5 mm</td> </tr> <tr> <td data-bbox="875 932 1077 954">300</td> <td data-bbox="1084 932 1294 954">6 mm</td> </tr> <tr> <td data-bbox="875 963 1077 986">350</td> <td data-bbox="1084 963 1294 986">7 mm</td> </tr> <tr> <td data-bbox="875 995 1077 1018">500</td> <td data-bbox="1084 995 1294 1018">10 mm</td> </tr> <tr> <td data-bbox="875 1027 1077 1050">750</td> <td data-bbox="1084 1027 1294 1050">15 mm</td> </tr> <tr> <td data-bbox="875 1059 1077 1082">1000</td> <td data-bbox="1084 1059 1294 1082">20 mm</td> </tr> </tbody> </table>	Length	Perm.bent	150	3 mm	250	5 mm	300	6 mm	350	7 mm	500	10 mm	750	15 mm	1000	20 mm			
Length	Perm.bent																			
150	3 mm																			
250	5 mm																			
300	6 mm																			
350	7 mm																			
500	10 mm																			
750	15 mm																			
1000	20 mm																			

# PERI Rental Criteria

## VTC Tunnel Formwork Carriage



Liftframe LALD (130955)	No.	Name	Article number
-------------------------	-----	------	----------------

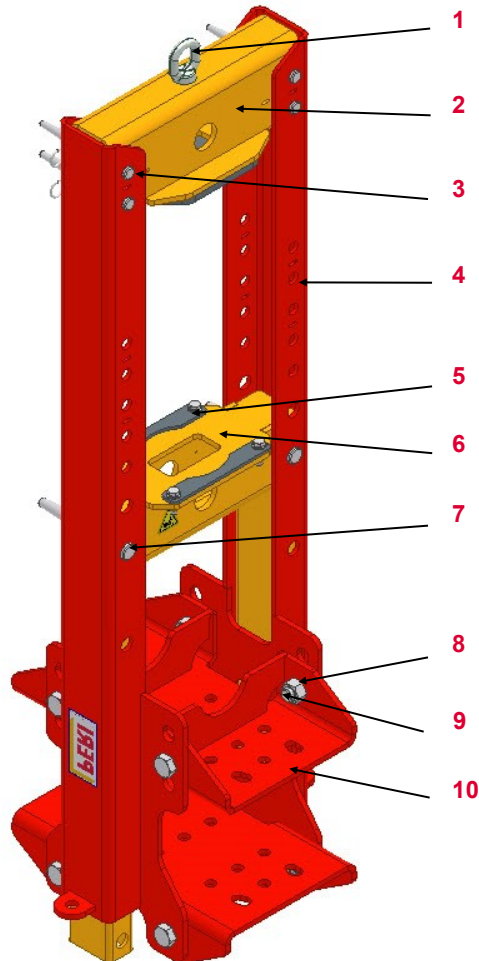











1	Crane Eye	710130
2	Yoke	130954
3	Pin 21x120	104031
4	Gallow	130950
5	Clamping Plate	130936
6	Sliding Part	130941
7	Pin 26x120	111567
8	Nut M24	022250
9	Bolt M24x50	109199
10	Beam Connector	130945

# PERI Rental Criteria

## VTC Tunnel Formwork Carriage



Liftrframe LALD (130955)	Description	Instruction	Billing	Type
	<p><b>Tube of sliding part bent</b></p> <ul style="list-style-type: none"> <li>■ If possible</li> <li>■ Or if not possible</li> </ul>	<p>     </p>	<p>     </p>	<p>     </p>
	<p><b>Bolts   Pins   Nuts missing</b></p>	<p>  </p>	<p>  </p>	<p>  </p>

# PERI Rental Criteria

## VTC Tunnel Formwork Carriage



Hingslide LALD (130902)	No.	Name	Article number
-------------------------	-----	------	----------------

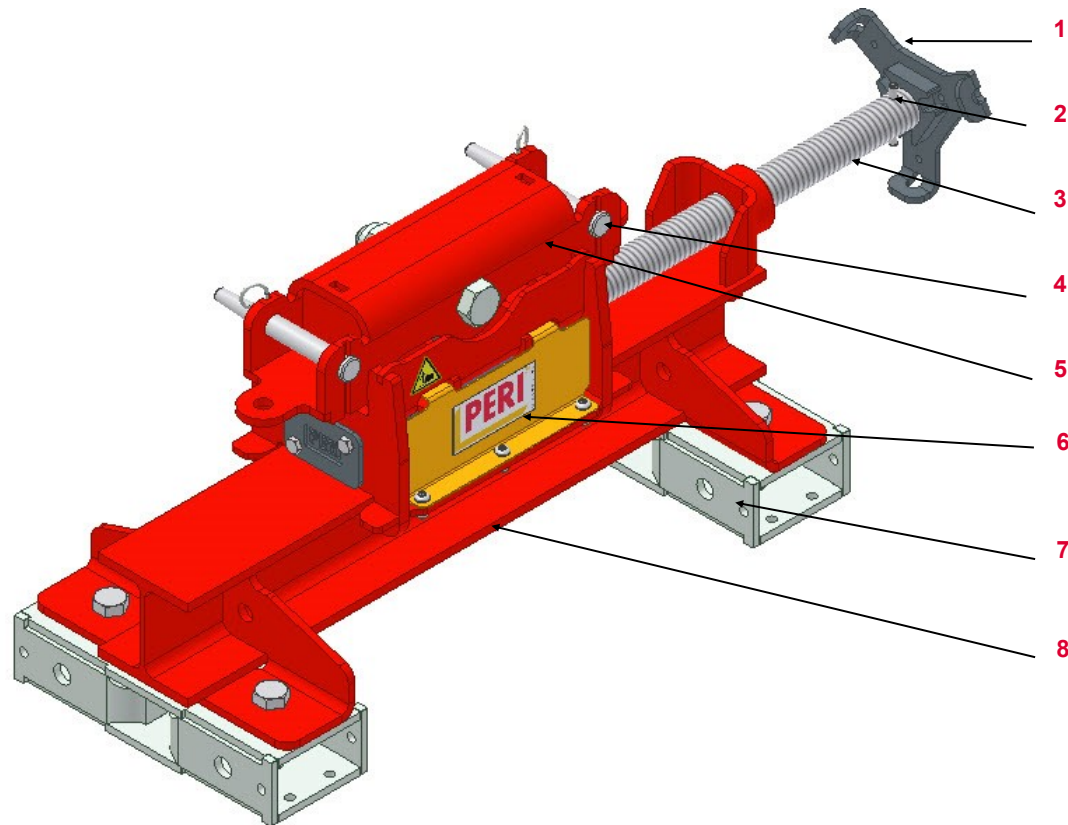















1	Spindle Head	130900
2	Sleeve 10x80	723338
3	Spindle	130894
4	Pin 26x120	111567
5	Rocker	130888
6	Side Protection Plate	130896
7	Base Profile	130882
8	Trestle	130872

# PERI Rental Criteria

## VTC Tunnel Formwork Carriage















Hingeslide LALD (130902)	Description	Instruction	Billing	Type
	<p><b>Wing of spindle Head bent</b></p> <ul style="list-style-type: none"> <li>■ If possible</li> <li>■ Or if not possible</li> </ul>	<ul style="list-style-type: none"> <li></li> <li></li> </ul>	<ul style="list-style-type: none"> <li></li> <li></li> </ul>	<ul style="list-style-type: none"> <li></li> <li></li> </ul>
	<p><b>Parts</b></p> <ul style="list-style-type: none"> <li>■ Missing</li> <li>■ Or damaged due to force</li> </ul>	<ul style="list-style-type: none"> <li></li> <li></li> </ul>	<ul style="list-style-type: none"> <li></li> <li></li> </ul>	<ul style="list-style-type: none"> <li></li> <li></li> </ul>

# PERI Rental Criteria

## VTC Tunnel Formwork Carriage



Hingeslide LALD (130902)	Description	Instruction	Billing	Type
	<p><b>Function of spindle disturbed</b></p> <ul style="list-style-type: none"> <li>■ If possible</li> <li>■ Or if not possible anymore</li> </ul>	<p>Lubricate afterwards</p> <ul style="list-style-type: none"> <li></li> <li></li> </ul>	<ul style="list-style-type: none"> <li></li> <li></li> </ul>	<ul style="list-style-type: none"> <li></li> <li></li> </ul>
	<p><b>Trestle bent</b></p>	<ul style="list-style-type: none"> <li></li> <li></li> </ul>	<ul style="list-style-type: none"> <li></li> </ul>	<ul style="list-style-type: none"> <li></li> </ul>

# PERI Rental Criteria

## VTC Tunnel Formwork Carriage



Telescopic Prop (131060)	No.	Name	Article number
--------------------------	-----	------	----------------

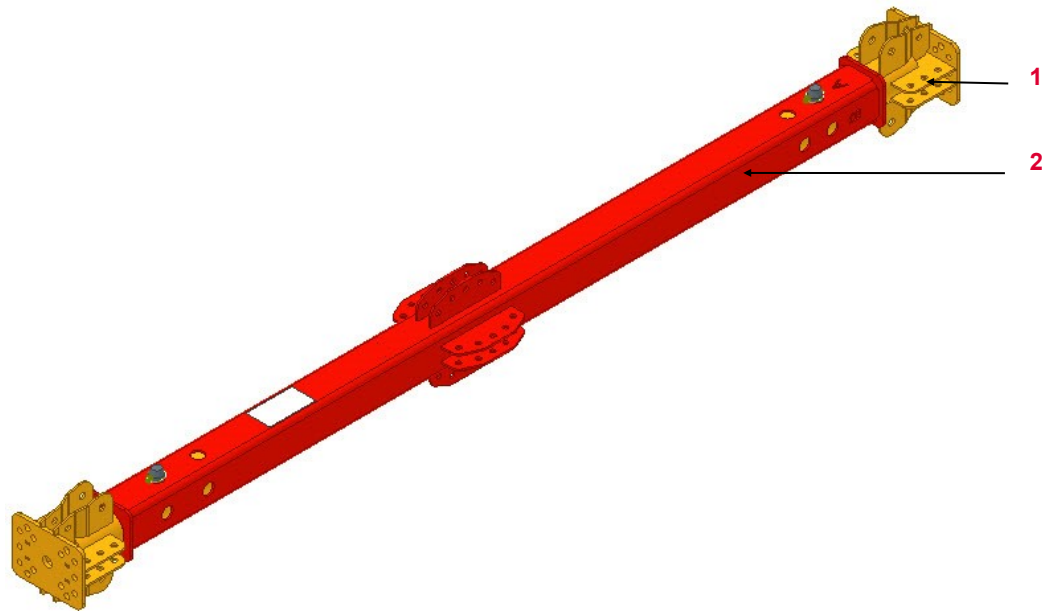



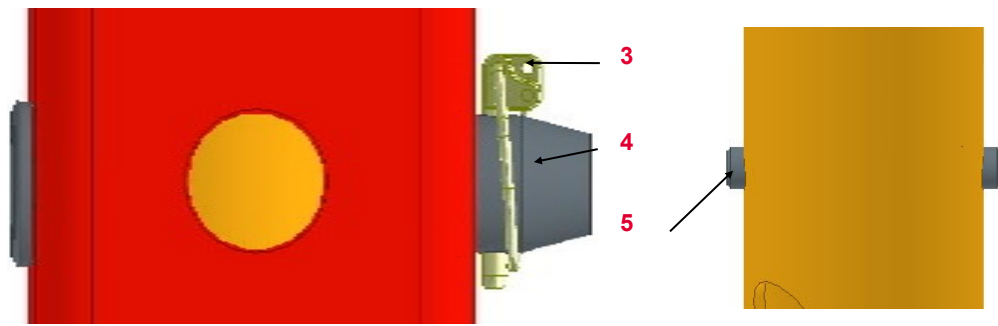







1	Telescopic Tube	131059
2	Middle Piece	131053
3	Linchpin	126417
4	Pin Telesopic Tube	131048
5	Secure Pin	131045

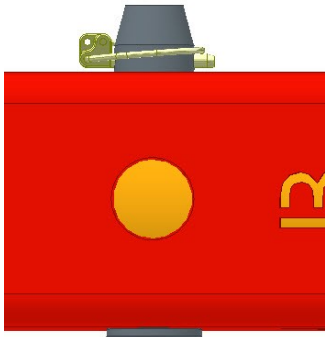

# PERI Rental Criteria

## VTC Tunnel Formwork Carriage











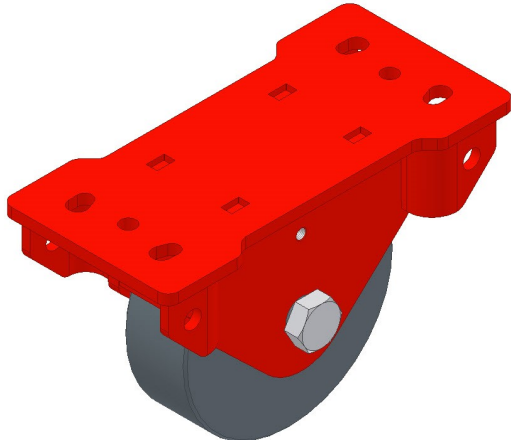

Telescopic Prop (131060)	Description	Instruction	Billing	Type
	<b>Plates bent</b>	<ul style="list-style-type: none"> <li>■ If possible</li> </ul> 		
	<ul style="list-style-type: none"> <li>■ Or if not possible</li> </ul>			
	<b>Bolt   Linchpin   Secure pin missing</b>			

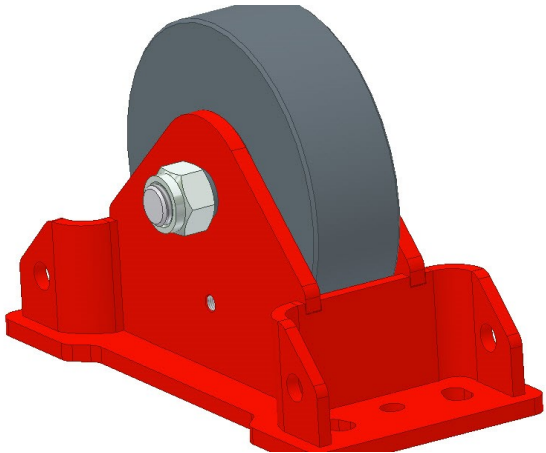
# PERI Rental Criteria

## VTC Tunnel Formwork Carriage









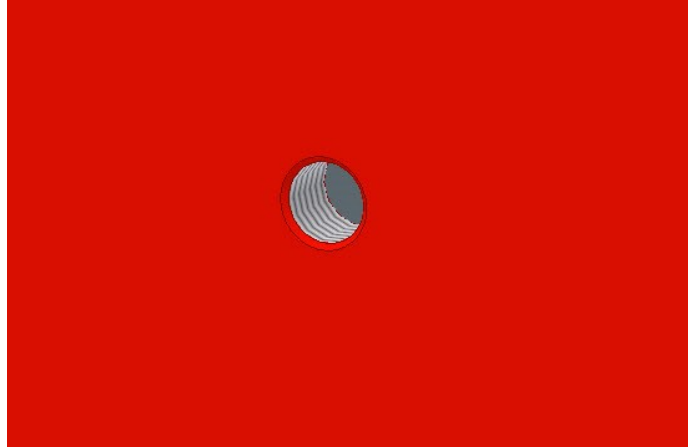

Heavy Duty Wheel (131001)	Description	Instruction	Billing	Type
	<p><b>Wheel damaged</b></p>	<p> 130989 (Wheel)</p>	<p></p>	<p></p>
	<p><b>Parts bent</b></p> <ul style="list-style-type: none"> <li>■ If possible</li> <li>■ Or if not possible</li> </ul>	<p></p> <p></p>	<p></p> <p></p>	<p></p> <p></p>

# PERI Rental Criteria

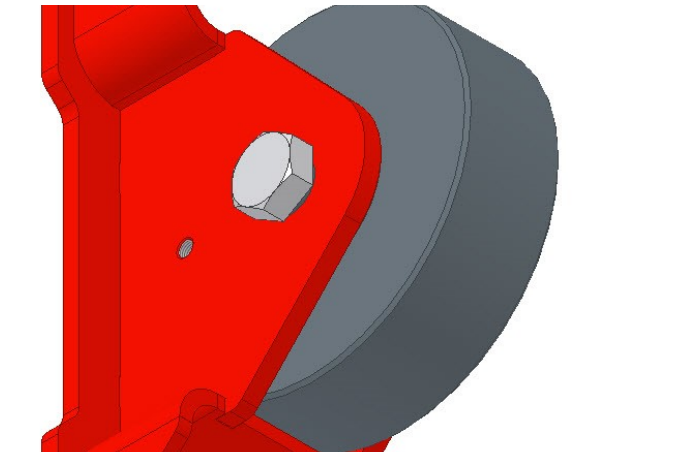
## VTC Tunnel Formwork Carriage













Heavy Duty Wheel (131001)	Description	Instruction	Billing	Type
	<b>Thread damaged</b>	<ul style="list-style-type: none"> <li data-bbox="846 566 1294 622"> <span data-bbox="846 566 1019 622">■ If possible</span> <span data-bbox="1294 550 1377 622"></span> <span data-bbox="1377 534 1568 566">Recut the thread</span> </li> </ul>		
	<ul style="list-style-type: none"> <li data-bbox="846 694 1294 742"> <span data-bbox="846 694 1086 742">■ Or if not possible</span> </li> </ul>	<span data-bbox="1294 694 1377 758"></span> <span data-bbox="1377 694 1451 758"></span>		
	<b>Function of wheel disturbed</b>	<ul style="list-style-type: none"> <li data-bbox="846 1077 1294 1133"> <span data-bbox="846 1077 1019 1133">■ If possible</span> <span data-bbox="1294 1061 1377 1133"></span> <span data-bbox="1377 1053 1769 1117">Check and lubricate spherical roller bearing</span> </li> </ul>		
	<ul style="list-style-type: none"> <li data-bbox="846 1204 1294 1252"> <span data-bbox="846 1204 1086 1252">■ Or if not possible</span> </li> </ul>	<span data-bbox="1294 1204 1377 1268"></span> <span data-bbox="1377 1204 1451 1268"></span>		

# PERI Rental Criteria

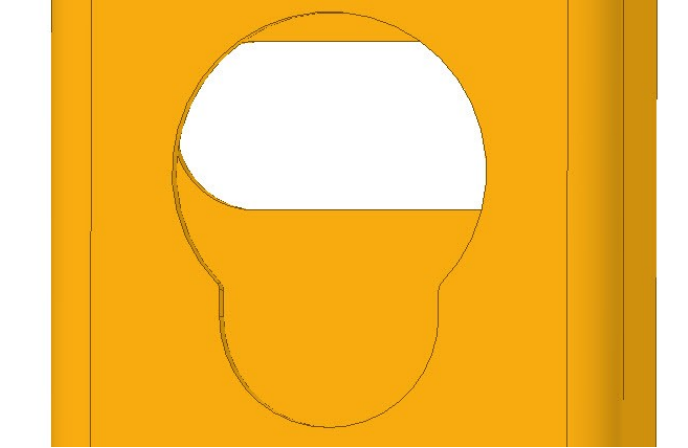
## VTC Tunnel Formwork Carriage







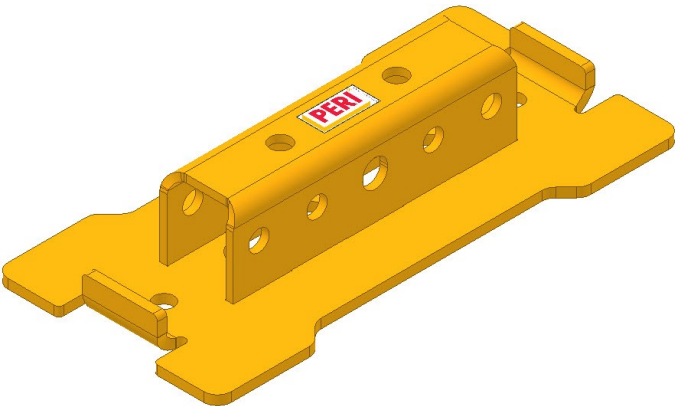

Flange Cage HDW (130981)	Description	Instruction	Billing	Type
	<p><b>Bent</b></p> <ul style="list-style-type: none"> <li>■ If possible</li> <li>■ Or if not possible</li> </ul>	<ul style="list-style-type: none"> <li></li> <li></li> </ul>	<ul style="list-style-type: none"> <li></li> <li></li> </ul>	<ul style="list-style-type: none"> <li></li> <li></li> </ul>
	<p><b>Keyhole hole worn</b></p>			

# PERI Rental Criteria

## VTC Tunnel Formwork Carriage



Adapter RCS HDW (130842)	Description	Instruction	Billing	Type
	<p><b>Bent</b></p> <ul style="list-style-type: none"> <li>■ If possible</li> <li>■ Or if not possible</li> </ul>	<ul style="list-style-type: none"> <li></li> <li></li> </ul>	<ul style="list-style-type: none"> <li></li> <li></li> </ul>	<ul style="list-style-type: none"> <li></li> <li></li> </ul>

# PERI Rental Criteria

## VTC Tunnel Formwork Carriage



Thrust Frame LALD HDW (130843)	Description	Instruction	Billing	Type
--------------------------------	-------------	-------------	---------	------



**Drill Holes**

- Original geometry given
- Or if not given anymore

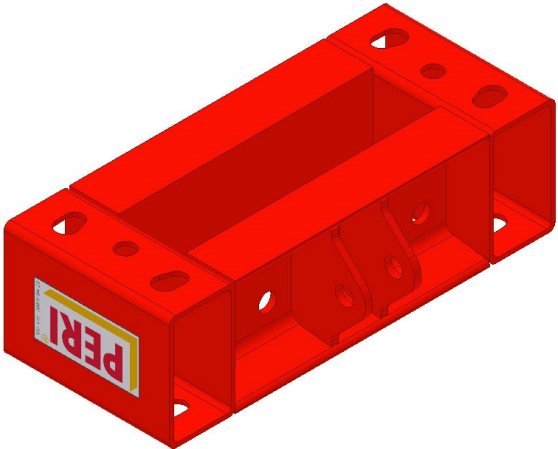

**Bent**







- If possible
- Or if not possible

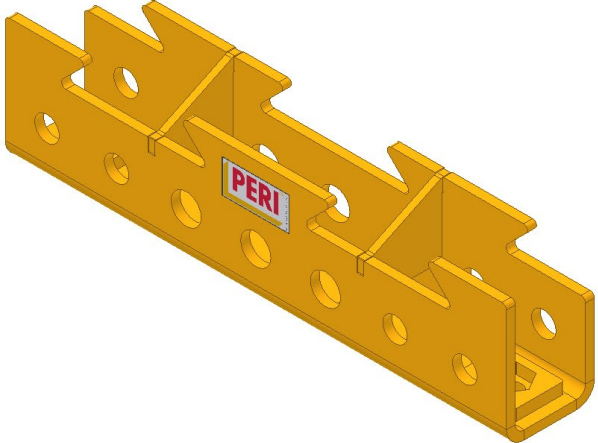

# PERI Rental Criteria

## VTC Tunnel Formwork Carriage







Multiadapter RCS VARIOKIT (130848)	Description	Instruction	Billing	Type
	<p><b>Bent</b></p> <ul style="list-style-type: none"> <li>■ If possible</li> <li>■ Or if not possible</li> </ul>	<ul style="list-style-type: none"> <li></li> <li></li> </ul>	<ul style="list-style-type: none"> <li></li> <li></li> </ul>	<ul style="list-style-type: none"> <li></li> <li></li> </ul>

# PERI Rental Criteria

## VTC Tunnel Formwork Carriage











Hydraulic Jack 250KN (130965)	Description	Instruction	Billing	Type
	Function not given	 		

# PERI Rental Criteria

## VTC Tunnel Formwork Carriage







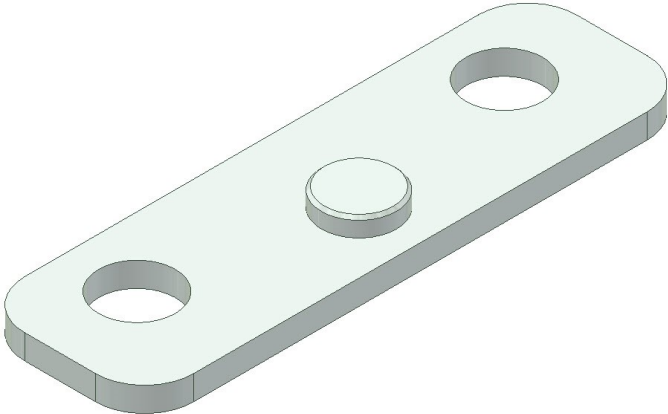

Lifting Tool LALD (131072)	Description	Instruction	Billing	Type
	<b>Hook   Adjusting Unit missing</b>	 131065 (Hook) 131067 (Adjusting Unit)		
	<b>Wedge   Robe   Linchpin</b>	 131064 (Wedge) 127303 (Rope) 128991 (Linchpin)		
	<ul style="list-style-type: none"> <li>Missing</li> </ul>			
	<ul style="list-style-type: none"> <li>Or damaged due to force</li> </ul>	 131064 (Wedge) 127303 (Rope) 128991 (Linchpin)		

# PERI Rental Criteria

## VTC Tunnel Formwork Carriage



Assembly Kit Thrust Frame (133911)	Description	Instruction	Billing	Type
	<p><b>Bent</b></p> <ul style="list-style-type: none"> <li>■ If possible</li> <li>■ Or if not possible</li> </ul>	<ul style="list-style-type: none"> <li></li> <li></li> </ul>	<ul style="list-style-type: none"> <li></li> <li></li> </ul>	<ul style="list-style-type: none"> <li></li> <li></li> </ul>

# PERI Rental Criteria

## VTC Tunnel Formwork Carriage







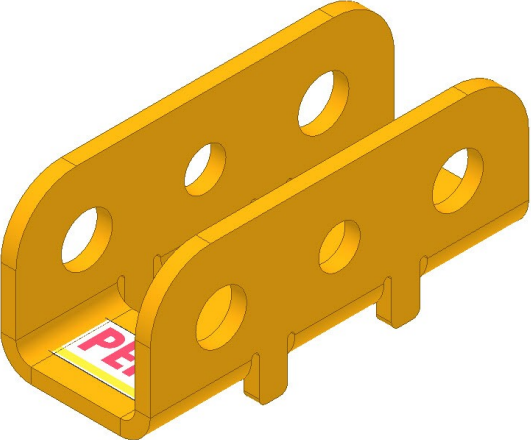

Support Wedgebox (130970)	Description	Instruction	Billing	Type
	Bent			
	■ If possible			
■ Or if not possible				

# PERI Rental Criteria

## VTC Tunnel Formwork Carriage









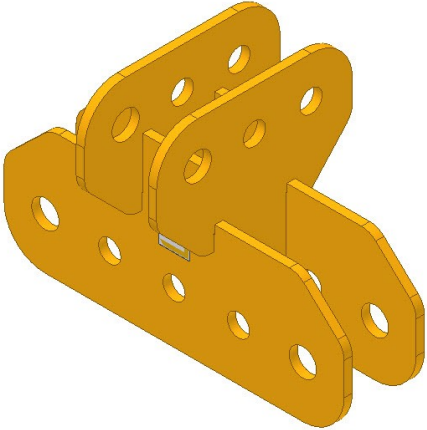

Connector RCS (130972)	Description	Instruction	Billing	Type
	<p><b>Bent</b></p> <ul style="list-style-type: none"> <li>■ If possible</li> <li>■ Or if not possible</li> </ul>	<p>     </p>	<p>     </p>	<p>     </p>

# PERI Rental Criteria

## VTC Tunnel Formwork Carriage









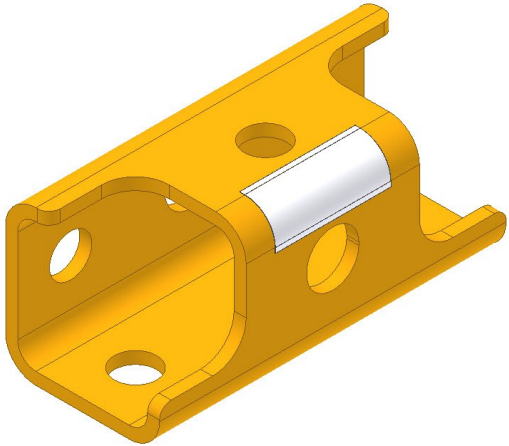

Vertical Connector RCS (129800)	Description	Instruction	Billing	Type
	<p><b>Bent</b></p>			
	<ul style="list-style-type: none"> <li>■ If possible</li> </ul>			
	<ul style="list-style-type: none"> <li>■ Or if not possible</li> </ul>	 		

# PERI Rental Criteria

## VTC Tunnel Formwork Carriage









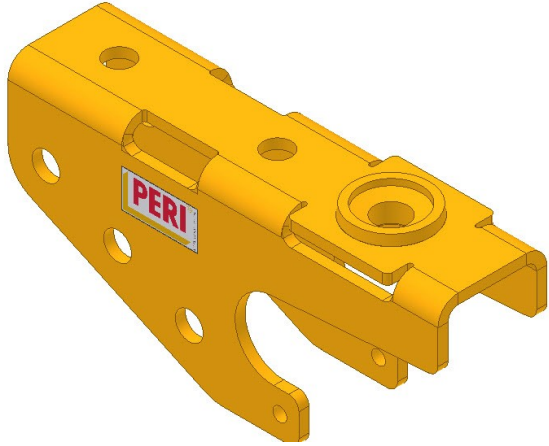

Cross Connector (131040)	Description	Instruction	Billing	Type
	<p><b>Bent</b></p>			
	<ul style="list-style-type: none"> <li>■ If possible</li> </ul>			
	<ul style="list-style-type: none"> <li>■ Or if not possible</li> </ul>	 		

# PERI Rental Criteria

## VTC Tunnel Formwork Carriage



Slab Shoe VARIOKIT (130820)	Description	Instruction	Billing	Type
	<p><b>Bent</b></p> <ul style="list-style-type: none"> <li>■ If possible</li> <li>■ Or if not possible</li> </ul>	<p>If possible: </p> <p>Or if not possible:  </p>	<p>If possible: </p> <p>Or if not possible: </p>	<p>If possible: </p> <p>Or if not possible: </p>

# PERI Rental Criteria

## VTC Tunnel Formwork Carriage







Hinge Connector RCS (130825)	Description	Instruction	Billing	Type
	Bent			
	<ul style="list-style-type: none"> <li>■ If possible</li> </ul>			
	<ul style="list-style-type: none"> <li>■ Or if not possible</li> </ul>			

# PERI Rental Criteria

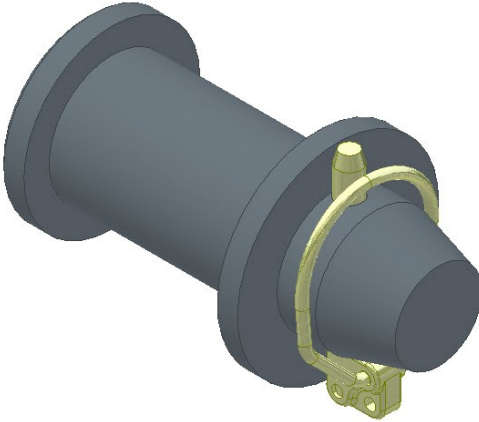
## VTC Tunnel Formwork Carriage



Pin Hinge Connector (130831)	Description	Instruction	Billing	Type
	Linch Pin missing	 126417		

# PERI Rental Criteria

## VTC Tunnel Formwork Carriage



















Heavy Duty Roller Swivel Plate (131811)	Description	Instruction	Billing	Type
	<b>Geometry of connection holes</b>			
	<ul style="list-style-type: none"> <li>■ Given</li> </ul>			
<ul style="list-style-type: none"> <li>■ Or not given</li> </ul>				

# PERI Rental Criteria

## Glossar Icons



Icon	Significance	Icon	Significance	Icon	Significance
	Not OK – Scrap		Compensation (customer)		Optical damage– it’s permitted to hand out
	OK— Article stays in Rental Park		No compensation		Functional damage– it’s permitted to hand out
	It’s <b>not</b> permitted to hand out the article because of security aspects		Shorten the article		Functional damage– it’s <b>not</b> permitted to hand out
	Repair according to Working Instruction		Mark the article		Static damage– it’s <b>not</b> permitted to hand out
	Fix article cold– Afterwards check weld seams and bordering components		Replace defect components		
	Repair after local profitability calculation		Replace missing components		
	Clean the article				